

Panasonic®

Multi-Media Projection Display Operating Instructions

Models No. **PT-40LC12/PT-45LC12**



For assistance, please call :
1-888-VIEW PTV(843-9788)
or send e-mail to :
consumerproducts@panasonic.com
or visit us at **www.panasonic.com**
(USA)

For assistance, please call :
787-750-4300
or visit us at **www.panasonic.com**
(Puerto Rico)

Three Important Reasons to Register Your Product Immediately!

1 Protect Your New Investment...

Register your new projection display for insurance purposes in case your new projection display is stolen.

2 Product safety notification...

Registering your product can help us to contact you in the unlikely event a safety notification is required under the Consumer Product Safety Act.

3 Improved Product Development...

Help us continue to design products that meet your needs.

Register online at **www.panasonic.com/register**

Important Safety Instructions



This symbol warns the user that uninsulated voltage within the unit may have sufficient magnitude to cause electric shock. Therefore, it is dangerous to make any kind of contact with any inside part of this unit.



This symbol alerts the user that important literature concerning the operation and maintenance of this unit has been included. Therefore, it should be read carefully in order to avoid any problems.



The pictorial representation of a hot surface within a triangle is intended to tell the user that parts inside the product are a risk of burns to persons.

Note to CATV System Installer: This reminder is provided to call the CATV system installer's attention to Article 820-40 of the NEC that provides guidelines for proper grounding and, in particular, specifies that the cable ground shall be connected to the grounding system of the building, as close to the point of cable entry as practical.

Important Safety Instructions For Projection display

1. Read and apply the operating instructions provided with your projection display.
2. Read all of the instructions given here and retain them for later use.
3. Follow all warnings and instructions marked on the projection display.
4. Unplug this projection display from the wall outlet before cleaning. Do not use liquid or aerosol cleaners. Use a damp cloth for cleaning.
5. Do not use attachments / accessories not recommended by the projection display manufacturer as they may cause hazards.
6. Do not use this projection display near water. For example: Avoid placing it near a bathtub, washbowl, kitchen sink, or laundry tub, in a wet basement, or near a swimming pool, etc.
7. Do not place this projection display on an unstable cart, stand or table. The projection display may fall, causing serious injury to a child or adult, and serious damage to the appliance. Use only with a cart or stand recommended by the manufacturer, or sold with the projection display.
- 7A. An appliance and cart combination shall be moved with care. Quick stops, excessive force, and uneven surfaces may cause the appliance and cart combination to overturn.
8. Slots and openings in the cabinet and the back are provided for ventilation, to ensure reliable operation of the projection display and to protect it from overheating. These openings must not be blocked or covered. There shall be at least 10 cm of space from these openings. The openings shall never be blocked by placing the projection display on a bed, sofa, rug or other similar surface. This projection display shall never be placed near or over a radiator or heat register. This projection display shall not be placed in a built-in installation such as a bookcase unless proper ventilation is provided.
9. Operate only from the type of power source indicated on the marking label. If you are not sure of the type of power supplied to your home consult your television dealer or local power company.
10. This projection display is equipped with a polarized alternating-current line plug (a plug having one blade wider than the other). This plug will fit into the power outlet only one way. This is a safety feature. If you are unable to insert the plug fully into the outlet, try reversing the plug. If the plug should still fail to fit, contact your electrician to replace your obsolete outlet. Do not defeat the safety purpose of the polarized plug.
11. Do not allow anything to rest and to pinch on the power cord. Do not locate this projection display where the power cord will be walked on.
12. Do not overload wall outlets and extension cords as this can result in fire or electric shock.
13. Never push objects of any kind into this projection display through cabinet slots as they may touch dangerous voltage points or short out parts that could result in a fire or electric shock. Never spill liquid of any kind on the projection display.

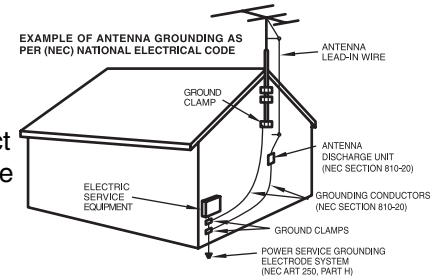

Important Safety Instructions

14. If an outside antenna is connected to the television equipment, be sure the antenna system is grounded so as to provide some protection against voltage surges and built up static charges. In the U.S. Selection 810 of the National Electrical Code provides information with respect to proper grounding of the mast and supporting structure, grounding of the lead-in wire to an antenna discharge unit, size of grounding conductors, location of antenna-discharge unit, connection to grounding electrodes, and requirements for the grounding electrode. See Figure.
15. For added protection for this projection display during a lightning storm, or when it is left unattended and unused for long periods of time, unplug it from the wall outlet and disconnect the antenna. This will prevent damage to the receiver due to lightning and power-line surges.
16. An outside antenna system shall not be located in the vicinity of overhead power lines or other electric light or power circuits, or where it can fall into such power lines or circuits. When installing an outside antenna system extreme care shall be taken to keep from touching such power lines or circuits as contact with them might be fatal.
17. Unplug this projection display from the wall outlet, and refer servicing to qualified service personnel under the following conditions:
 - a. When the power cord or plug is damaged or frayed.
 - b. If liquid has been spilled into the projection display.
 - c. If the projection display has been exposed to rain or water.
 - d. If the projection display does not operate normally by following the operating instructions. Adjust only those controls that are covered by the operating instructions as improper adjustment of other controls may result in damage and will often require extensive work by a qualified technician to restore the projection display to normal operation.
 - e. If the projection display has been dropped or the cabinet has been damaged.
 - f. When the projection display exhibits a distinct change in performance - this indicates a need for service.
18. Do not attempt to service this projection display yourself as opening or removing covers may expose you to dangerous voltage or other hazards. Refer all servicing to qualified service personnel.
19. When replacement parts are required, be sure the service technician has used replacement parts specified by the manufacturer that have the same characteristics as the original part. Unauthorized substitutions may result in fire, electric shock, or other hazards.
20. Upon completion of any service or repairs to this projection display, ask the service technician to perform routine safety checks to determine that the projection display is in safe operating condition.
21. **WARNING: To prevent fire or shock hazard, do not expose this appliance to rain or moisture.**
22. **WARNING:** Because the temperature of the lamp unit is elevated immediately after its use, directly touching it may cause burns. After the lamp has cooled enough, replace the lamp unit.
23. **CAUTION:** To prevent electric shock, match wide blade of plug to wide slot of AC outlet and fully insert. Do not use this (polarized) plug with a receptacle or other outlet unless the blade can be fully inserted to prevent blade exposure.

This product has a High Intensity Discharge (HID) lamp that contains a small amount of mercury. It also contains lead in some components.
Disposal of these materials may be regulated in your community due to environmental considerations.
For disposal or recycling information please contact your local authorities, or the Electronics Industries Alliance:
<<http://www.eiae.org>>

Clean the air filter regularly. Not cleaning the air filter could shorten the life of the set.

**The lamp has a maximum life of about 5 000 hours.
If use exceeds this figure, the possibility of lamp damage becomes greater.
The lamp should be changed as soon as possible once the lamp warning message appears.
If the lamp is damaged, please contact your nearest dealer.**

When VIEWING MODE is set to CINEMA, brightness will be reduced, but the life of the LCD panel can be prolonged. Therefore, the CINEMA setting is recommended when possible.

Dear Panasonic Customer

Welcome to the Panasonic family of customers. We hope that you will have many years of enjoyment from your new projection television set.

To obtain maximum benefit from your set, please read these Instructions before making any adjustments, and retain them for future reference.

Retain your purchase receipt also, and record the serial number of your set in the space provided on the rear cover of these instructions.

Visit our Panasonic Web Site for USA : www.panasonic.com

For assistance, please call : 1-888-VIEW PTV(843-9788)
or send e-mail to : consumerproducts@panasonic.com
or visit us at www.panasonic.com (USA)

For assistance, please call : 787-750-4300
or visit us at www.panasonic.com (Puerto Rico)

Trademarks

- Licensed by BBE Sound, Inc. under USP4638258 and 4482866. BBE and BBE symbol are registered trademarks of BBE Sound, Inc.
 - VGA and XGA are trademarks of International Business Machines Corporation.
 - Macintosh is a registered trademark of Apple Computer, USA.
 - VESA and SVGA are trademarks of the Video Electronics Standard Association.
- Even if no special notation has been made of company or product trademarks, these trademarks have been fully respected.
- Equipped with **dbx**[®]-TV Noise Reduction for true MTS reproduction. **dbx**[®]-TV Noise Reduction is required for good stereo separation and audio fidelity. **dbx**[®] is a registered trademark, and is licensed by **dbx**[®] Technology Licensing.

FCC STATEMENT:

NOTE: This equipment has been tested and found to comply with the limits for a Class B digital device, pursuant to Part 15 of the FCC Rules. These limits are designed to provide reasonable protection against harmful interference in a residential installation. This equipment generates, uses and can radiate radio frequency energy and, if not installed and used in accordance with the instructions, may cause harmful interference to radio communications. However, there is no guarantee that interference will not occur in a particular installation. If this equipment does cause harmful interference to radio or television reception, which can be determined by turning the equipment off and on, the user is encouraged to try to correct the interference by one or more of the following measures:

- Reorient or relocate the receiving antenna.
- Increase the separation between the equipment and receiver.
- Connect the equipment into an outlet on a circuit different from that to which the receiver is connected.
- Consult the dealer or an experienced radio / TV technician for help.

FCC CAUTION:

To assure continued compliance and prevent undesirable interference, use only the provided shielded VGA cable with 2 ferrite cores while connecting the Projection display to a computer. Any changes or modifications not expressly approved by the party responsible for compliance could void the user's authority to operate this equipment.

Declaration of Conformity

Model Number: **PT-40LC12/PT-45LC12**
Trade Name: **Panasonic**
Responsible party: Matsushita Electric Corporation of America.
Address: One Panasonic Way Secaucus New Jersey 07094
Telephone number: 1-888-VIEW PTV(843-9788)

This device complies with Part 15 of the FCC Rules. Operation is subject to the following two conditions: (1) This device may not cause harmful interference, and (2) this device must accept any interference received, including interference that may cause undesired operation.

Table of Contents

**TO
Start !**

Important Safety Instructions	2
Before Using	6
Receiver Location	6
Optional External Equipment	6
Safety Precaution	6
Viewing position	6
Accessories	7
Remote Control Battery Installation	7
Location of Controls	8
Illuminated Remote Control	8
Controls and Terminals on the projection display	10
Installation	12
Connecting the Antenna/Cable to the RF In Terminal (No VCR)	12
Connecting the Antenna/Cable to the RF In Terminal (VCR)	14
How to connect the "1, 2, 3" Input Terminals	15
How to connect the COMPONENT VIDEO Input Terminals	16
How to connect the AV Out Terminals	17
How to connect the PC Input Terminals	18
Analog RGB signals that can be input	19

**Use
Now !**

Power ON / OFF	20
Initial Setup	20
Turning the Power ON and OFF	21
Flow Chart of Main menu	22
Tuning channels	24
Automatic channel setting	24
Manual channel setting	26
Projection display operation	28
TV Status display	29
Using the number keys	29
Using projection display Channel up/down buttons to select input mode	29
Auto shut off	29
Invalid operation notice feature	29
ASPECT Controls	30
Searching for the desired channel (Channel search)	32
Playing peripheral equipment	33
Mute / Freeze / SAP	34
Split screen	36
Picture in Picture (PIP) Screen	38

**Enjoy
more !**

Adjusting screen position and size	40
Audio Adjustments	42
Picture Adjustments	44
Lock Feature	46
Closed Captions	50
Channel Caption Feature	52
Weak Signal Display Feature	53
Video NR (Noise Reduction) Feature	54
Automatically changing screen size	55
Setting when 480p signals (sequential scan) are input through COMPONENT VIDEO INPUT	55
RGB Input Feature	56
Switching languages for display	57
Information	57

**Other
Information !**

Cleaning the Air Filter	58
Clogged Air Filter Detection	59
Air Filter Replacement	59
Replacing the lamp unit	60
Remote Control Quick Reference Guide (Operating peripheral equipment)	61
Troubleshooting	68
Specifications	69
Cleaning	70
Customer Services Directory	70
Limited Warranty	71
Index	Back Cover

Getting Started

Basic Operation

Advanced Operation

Information

Before Using

Receiver Location

This unit is intended to be used with an optional stand or entertainment center. Consult your dealer for available options.

Locate for comfortable viewing. Avoid placing where sunlight or other bright light (including reflections) will fall on the screen.

Use of some types of fluorescent lighting can reduce remote control transmitter range.

Adequate ventilation is essential to prevent internal component failure. Keep away from areas of excessive heat or moisture.

Optional External Equipment

The Video / Audio connection between components can be made with shielded video and audio cables. For best performance, video cables should utilize 75 Ω coaxial shielded cables. Cables are available from your dealer or electronic supply house.

Before you purchase any cables, be sure you know what type of output and input connectors your various components require. Also determine the length of cable you'll need.

Safety Precaution

Please take safety precautions to prevent the unit from falling over.

The unit may fall over during earthquakes, or if someone stands on or shakes the projection display.

Fixing to a wall

Use a strong rope or a chain (not included) to fasten the projection display firmly to a strong support such as a wall or pillar.

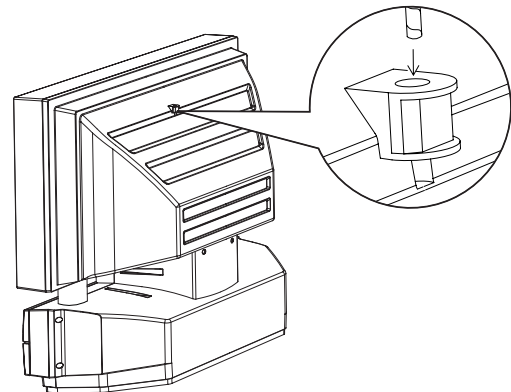

Viewing position

To optimize your viewing comfort, please follow the viewing guidelines shown in the diagrams below.

If viewing for an extended period of time, sit as far back from the screen as possible.

<Side view>

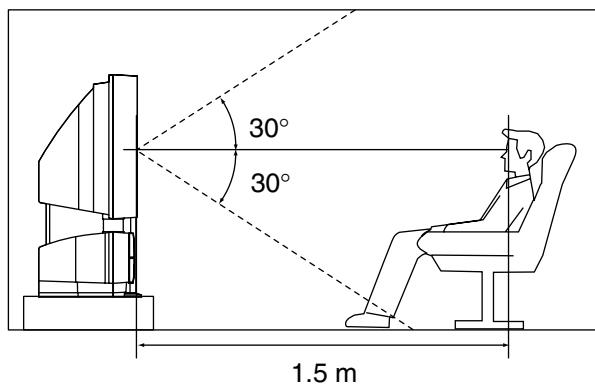

<Top view>

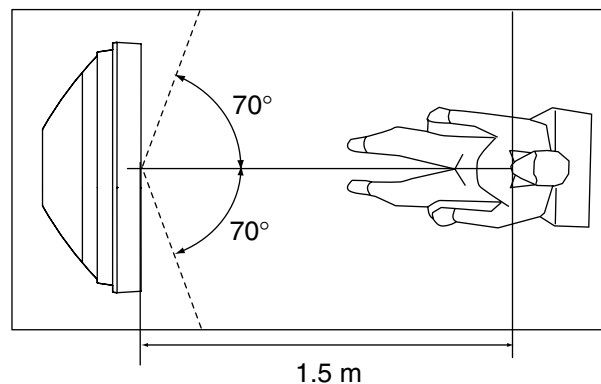

Accessories

- (1) Remote Control (EUR7603Z80)
- (2) Batteries 2 "AA"
- (3) RGB Cable (2 m) (LSJA0239-1 or LSJA0443)
- (4) Accessory Air Filter (LSYC0239)

Remote Control Battery Installation

Requires two AA batteries (supplied).

1. Turn the Transmitter face down. Remove top cover by pressing down on marking and sliding cover off in the direction indicated.
2. Install the batteries as shown in the battery compartment. (Polarity + or – must match the markings in the compartment).
3. Replace the cover and slide in reverse until the lock snaps.

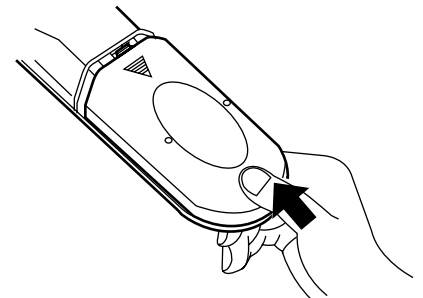
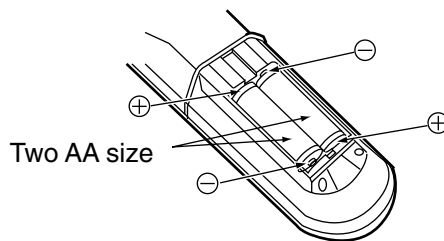
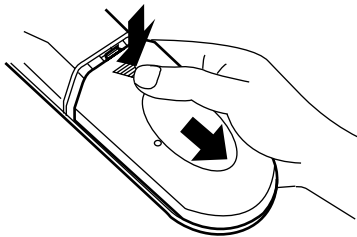

Helpful Hint:

For frequent remote control users, replace old batteries with Alkaline batteries for longer life.

⚠ Precaution on battery use

Incorrect installation can cause battery leakage and corrosion that will damage the remote control transmitter.

Observe the following precautions:

1. Batteries should always be replaced as a pair. Always use new batteries when replacing the old set.
2. Do not mix battery types (example: "Zinc Carbon" with "Alkaline").
3. Do not attempt to charge, short-circuit, disassemble, heat or burn used batteries.
4. Battery replacement is necessary when the remote control acts sporadically or stops operating the projection display set.

Helpful Hint:

Whenever you remove the batteries, **you may need to reset the remote control infrared codes.** We recommend that you record the code on page 62, prior to setting up the remote.

Location of Controls

Illuminated Remote Control

POWER button

Press to turn the projection display ON or OFF. (P. 21)

MUTE button

Press this button to mute the sound. (P. 34)

Mode Selection buttons

Selects the operation mode for the remote control. (PP. 61-67)

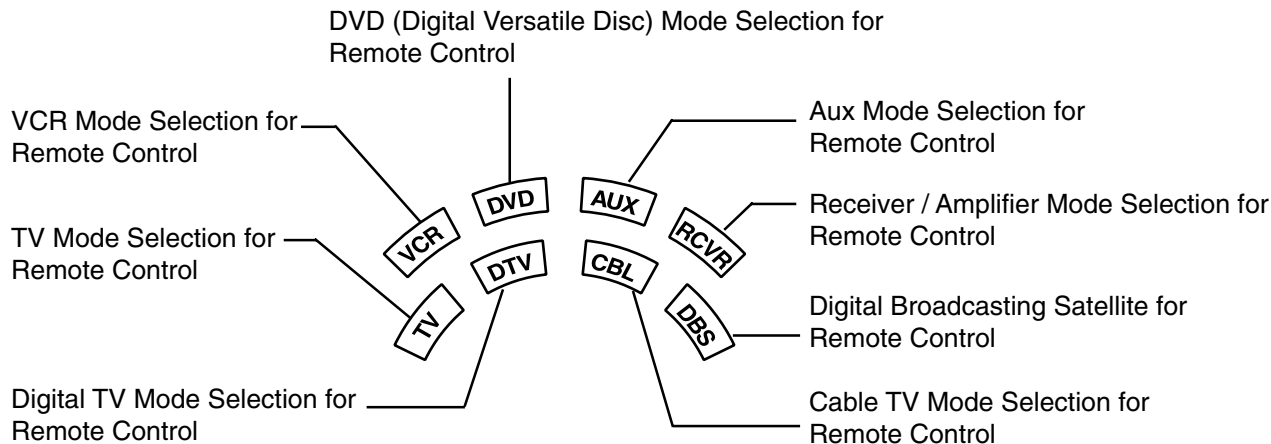

Number keys

When 6 is pressed, channel 6 is displayed in single screen. (P. 29)

R-TUNE button

Press to view previous channel or video mode.

Function buttons

MOVE REW 	PIP PLAY 	SPLIT/SIZE FF 	FREEZE PAUSE 	SWAP STOP
PIP Move (P. 39)	PIP ON/OFF (P. 38)	SPLIT Function/ PIP SIZE (PP. 36, 39)	FREEZE (P. 34)	PIP/SPLIT SWAP (PP. 37, 39)

SEARCH REC 	PIP CH VCR/DBS CH SLOW	PIP CH VCR/DBS CH SLOW	BBE OPEN/CLOSE
CH Search (P. 32)	PIP/SPLIT CH Down (PP. 37, 39)	PIP/SPLIT CH Up (PP. 37, 39)	BBE sound ON/OFF (P. 43)

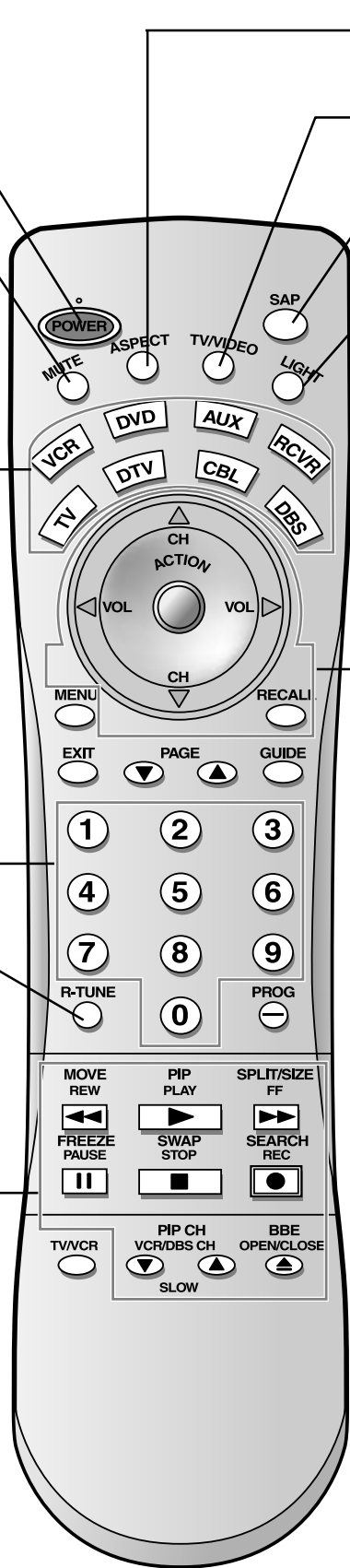

ASPECT button

Changes the screen size. (P. 30)

TV/VIDEO button

This input mode changes each time this button is pressed. (P. 33)

SAP button

Changes the audio mode. (P. 35)

Light button

Lights all buttons. The selected mode button (TV, VCR, etc.) flashes.

Display menu

Press the ACTION button to display Menu screen

Changes to the next channel up

Reduces volume

Increase volume

Changes to the next channel down

The screen below is displayed for 5 seconds.

(P. 29)

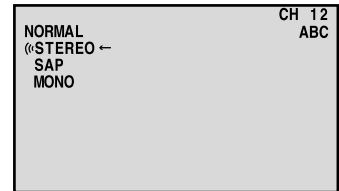

When the Menu screen is displayed, (PP. 22, 23)

Moves cursor upward during menu mode.

Moves cursor to the left during menu mode.

Moves cursor to the right during menu mode.

Sets the items.

Moves cursor downward during menu mode.

Returns to normal viewing from the MENU screen. Previous before item in MENU.

Note:

This section describes TV mode only. For other modes, see pages 61-67.

Location of Controls

Controls and Terminals on the projection display

< FRONT >

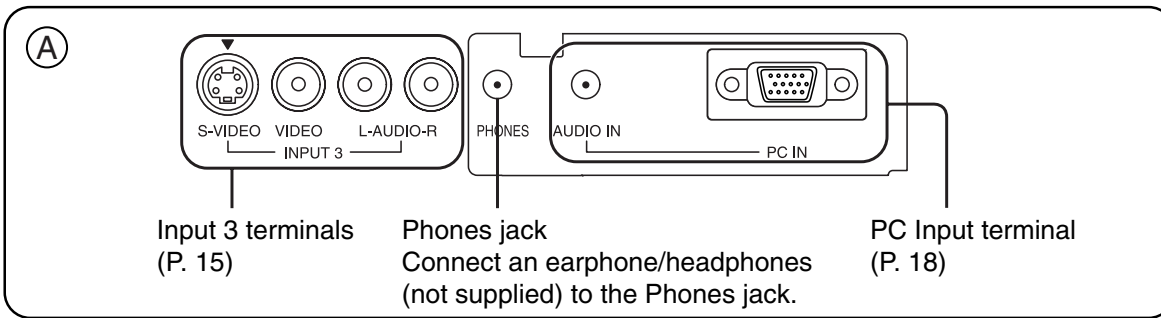
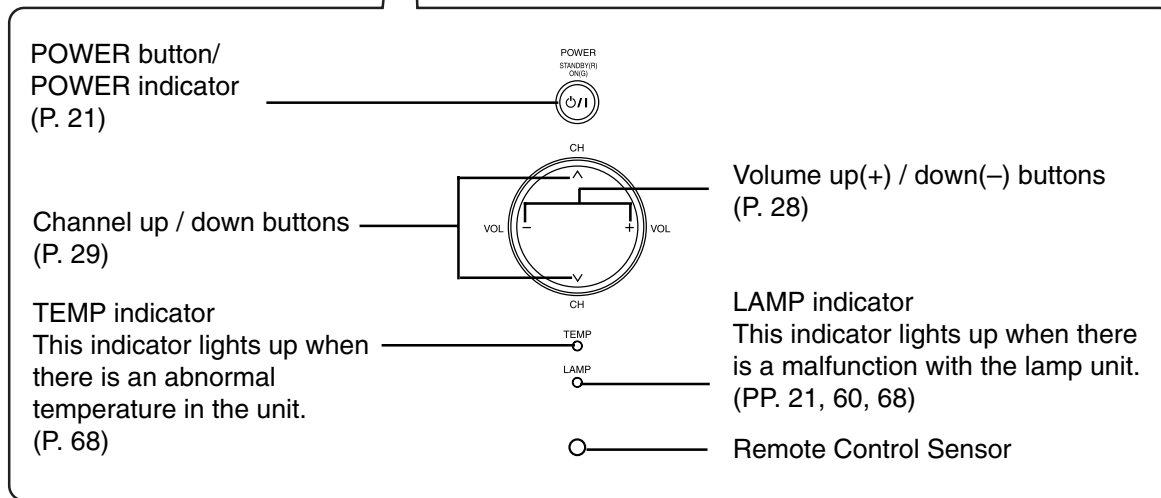
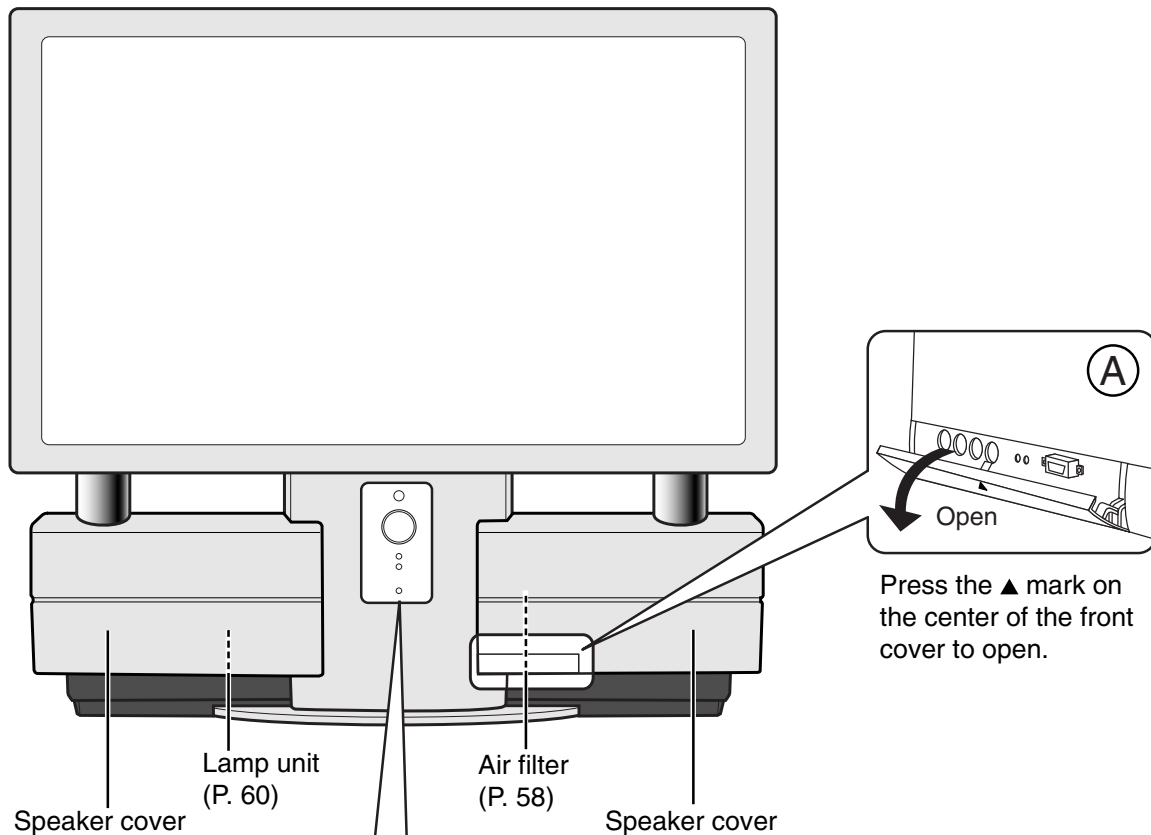

< REAR >

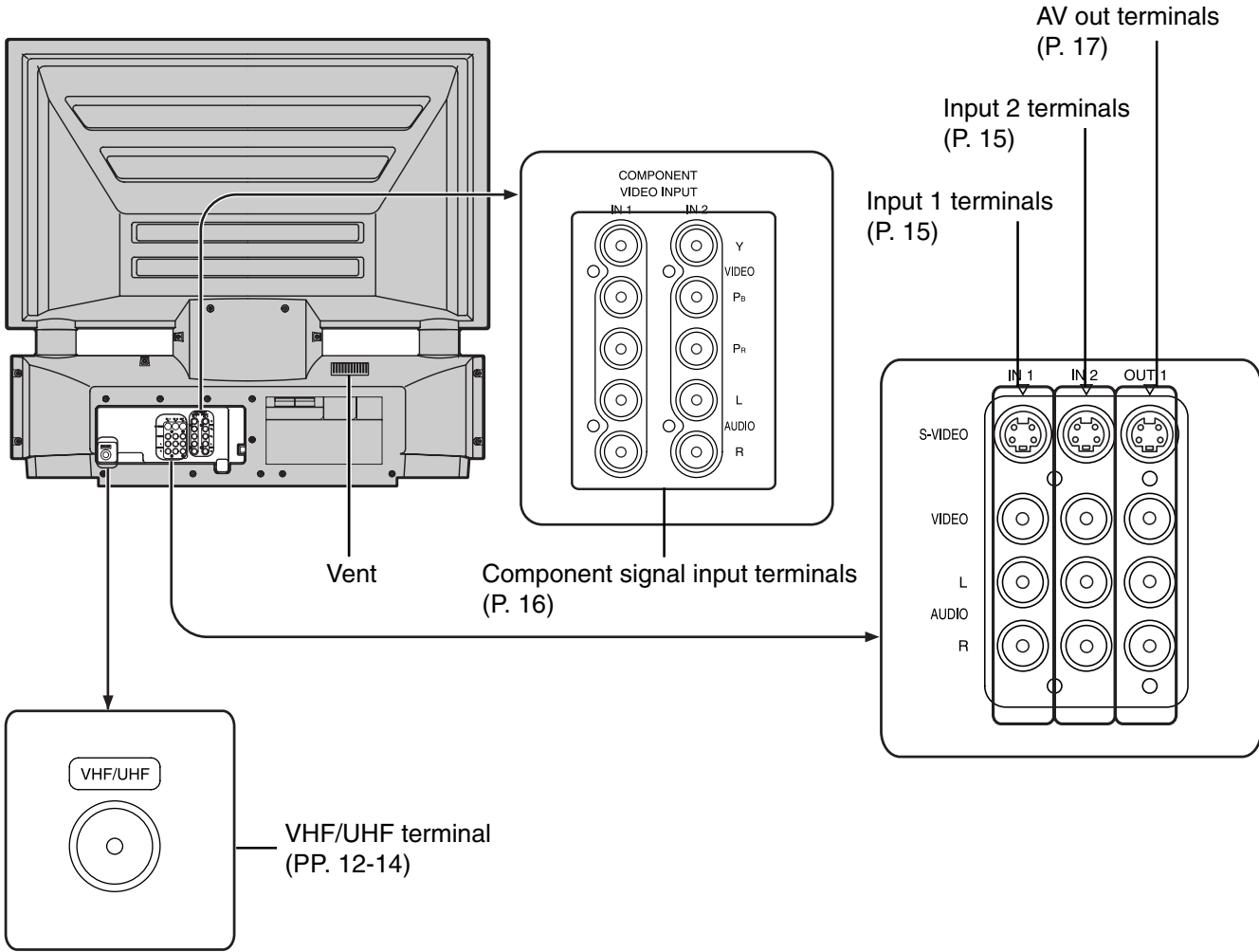

Note:
Make sure the vent is not clogged. (This could cause damage.)

Installation

Notes on connections

- Turn off the power supply for all components before making any connections.
- If the cables necessary for connecting a component to the system are not included with the component or available as an option, you may need to fashion a cable to suit the component concerned.
- Read the instruction manual for each system component carefully before connecting it.
- If there is a lot of jitter in the video signal input from the video source, the picture on the screen may flicker. In this case, it will be necessary to connect a TBC (time base corrector).

Connecting the Antenna / Cable to the RF in Terminal (No VCR)

Antenna Connection

For proper reception of VHF / UHF channels, an external antenna is required. For best reception an outdoor antenna is recommended.

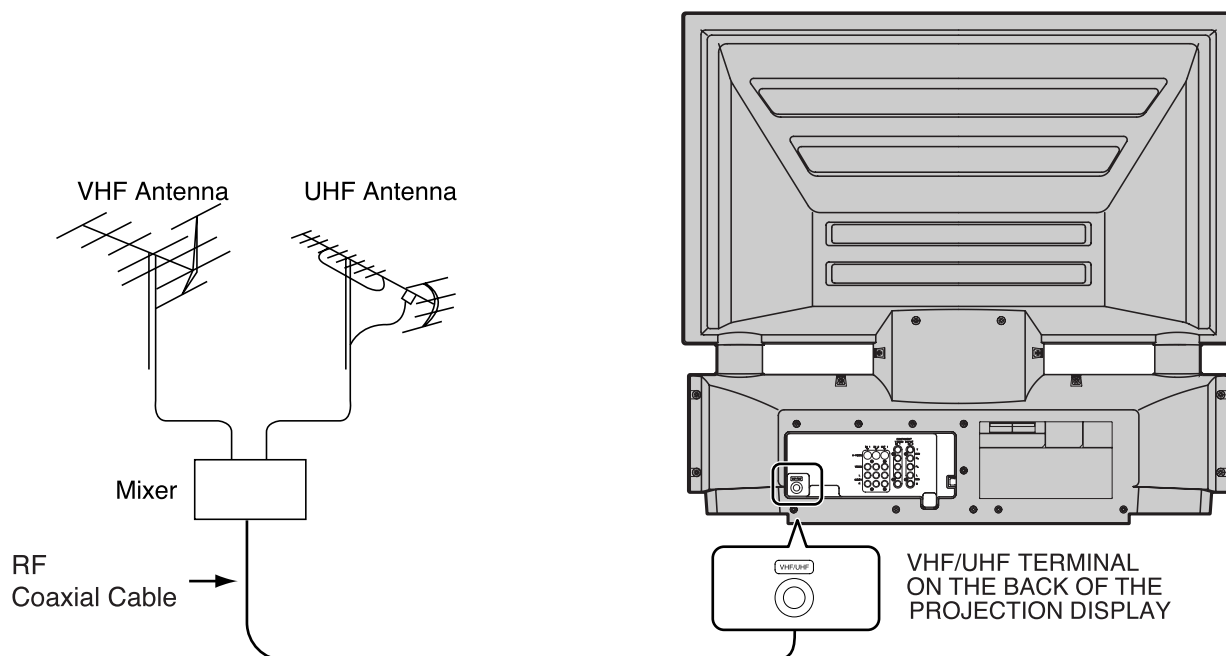

WARNING

When using "Nut type" RF coaxial cables, tighten with fingers only. Overtightening may damage terminals.

Cable Connection

Use this configuration when connecting the projection display to a cable TV system.

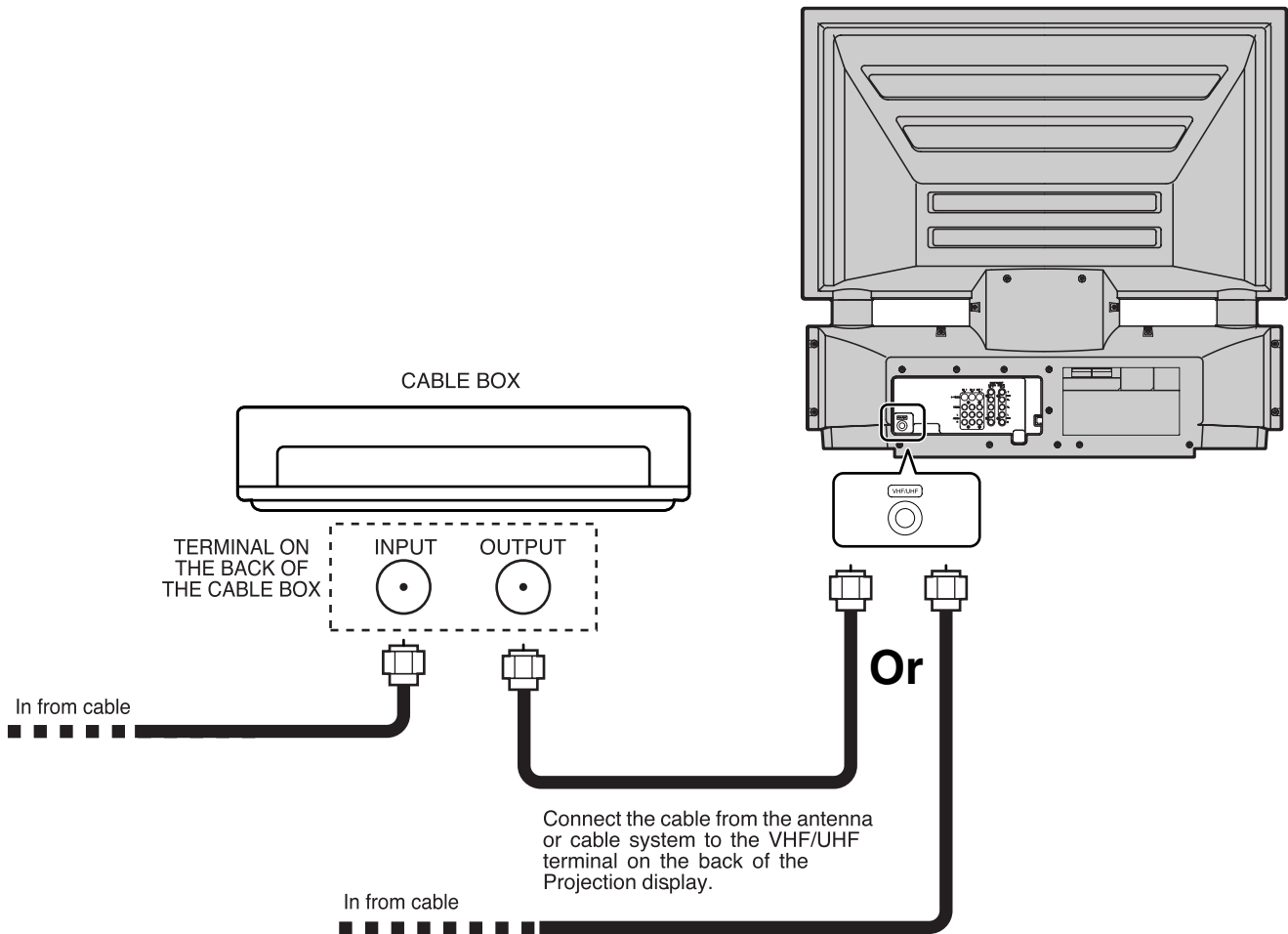

Notes:

- Certain cable systems offset some channels to reduce interference or have Premium (scrambled) channels. A cable converter box is required for proper reception. Check with your local Cable company for its compatibility requirements.
- For reception of cable channels (01 - 125) connect the cable supplied by your local cable company. Antenna Mode must be set to CABLE. (P. 24)

Installation

Connecting the Antenna / Cable to the RF in Terminal (VCR)

Use this configuration when connecting the projection display to a cable TV system using VCR.

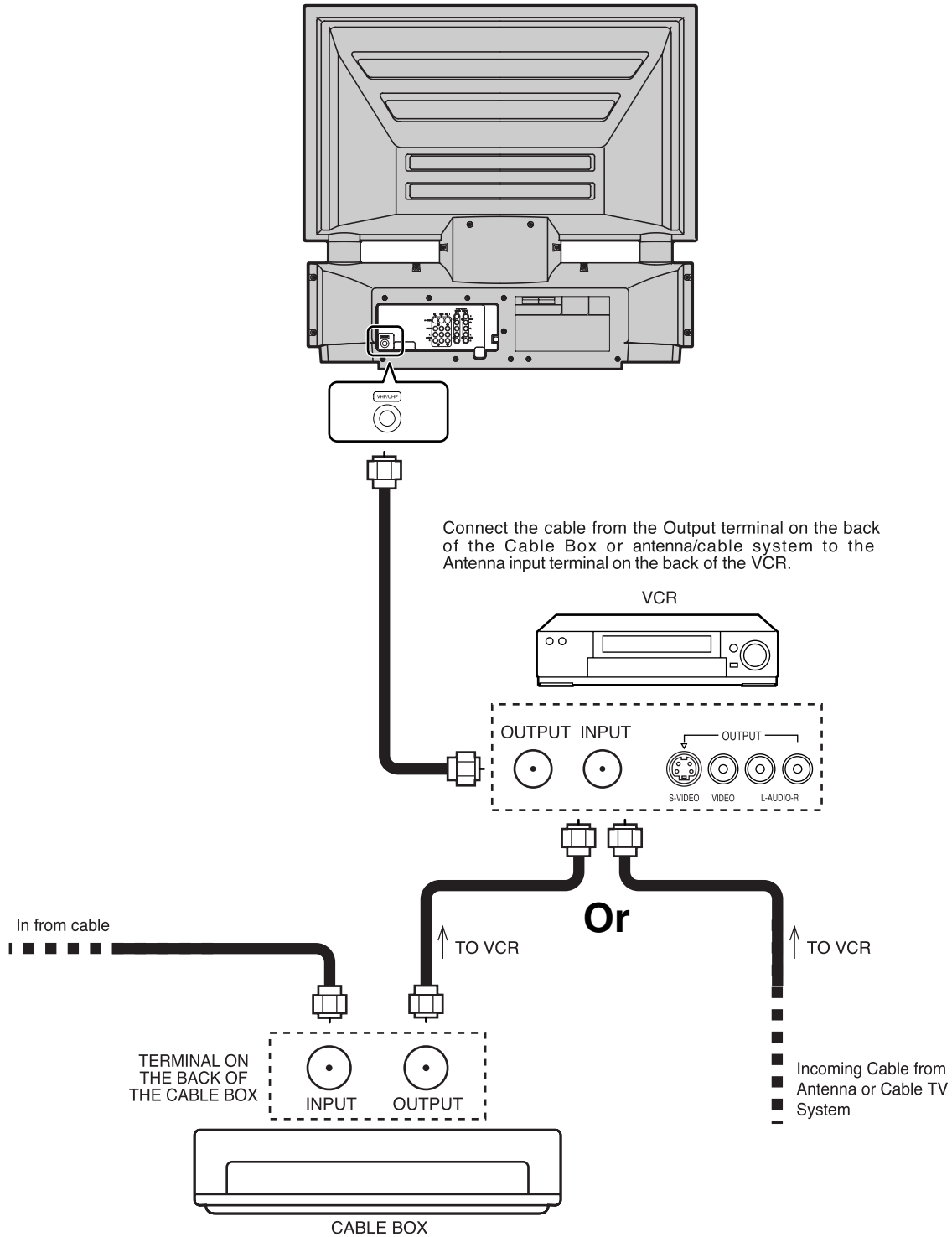

Notes:

- When the RF coaxial cable is connected to the projection display VHF/UHF terminal via a cable box or VCR, set the TV channel to CH3 or CH4. This does not apply when signal is input from VIDEO INPUT.

How to connect the “1, 2, 3” Input Terminals

Connects VCRs and other peripheral equipment

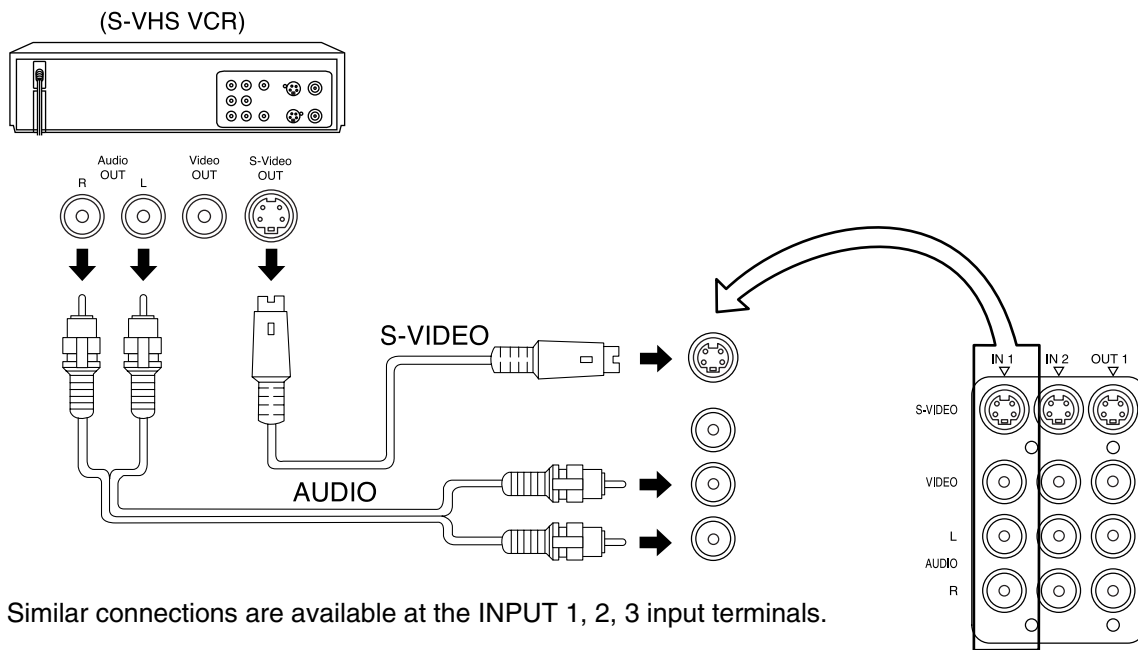

Similar connections are available at the INPUT 1, 2, 3 input terminals.

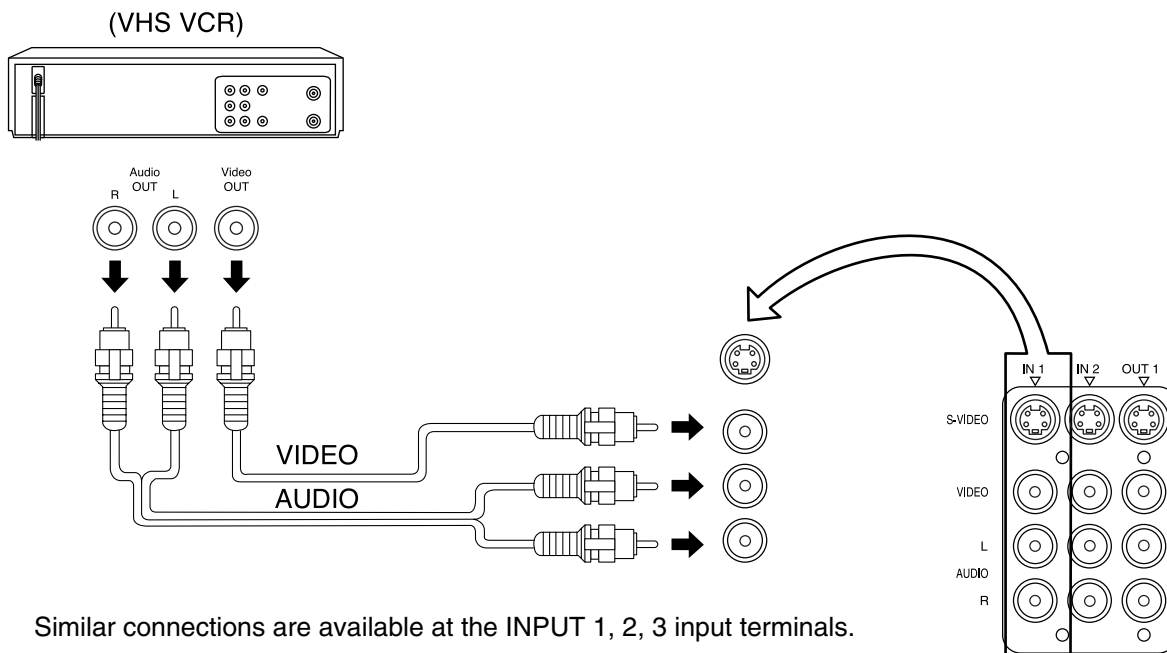

Similar connections are available at the INPUT 1, 2, 3 input terminals.

Notes:

- Similar connections are available at the INPUT 1, 2, 3 input terminals.
- Input 3 is located on the front of the unit.
- Select the desired VIDEO input position by pressing the TV/VIDEO button. (P. 33)
- When connecting video cables, priority is given to the S-Video cable when the S-Video input terminal and the video input terminal are connected at the same time.

Installation

How to connect the COMPONENT VIDEO Input Terminals

Because each Y, PB, and PR signal is input independently, the Component signal allows for more accurate color reproduction.

The Component signal output terminal indication will differ according to the output device (Y, PB / Cb, PR / Cr). Please read the operating instructions included with the output device.

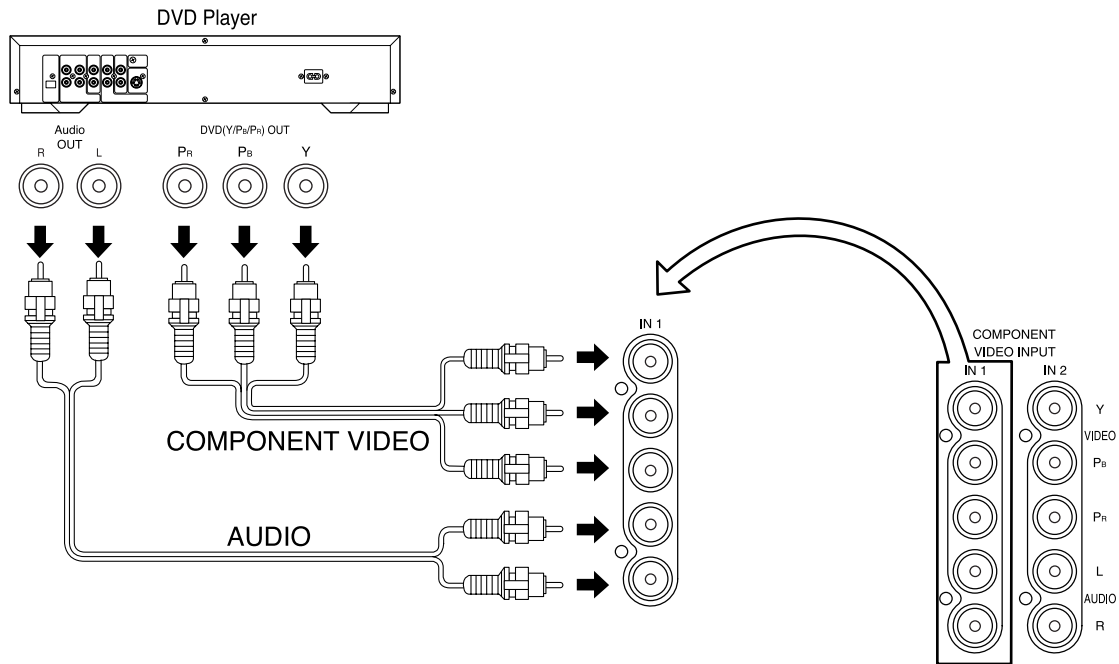

Notes:

- Similar connections are available at the COMPONENT VIDEO INPUT 1, 2 Terminals.
- Select the desired COMPONENT VIDEO INPUT position by pressing the TV/VIDEO button. (P. 33)
- Component video signals that can be input are 480i, 480p, 720p, and 1080i.

How to connect the AV Out Terminals

The “AV Out” Terminals output the same signals as the main picture on the projection display screen and sound from the speaker at that time, e.g. TV programs or signals from INPUT 1, 2, 3 terminals.

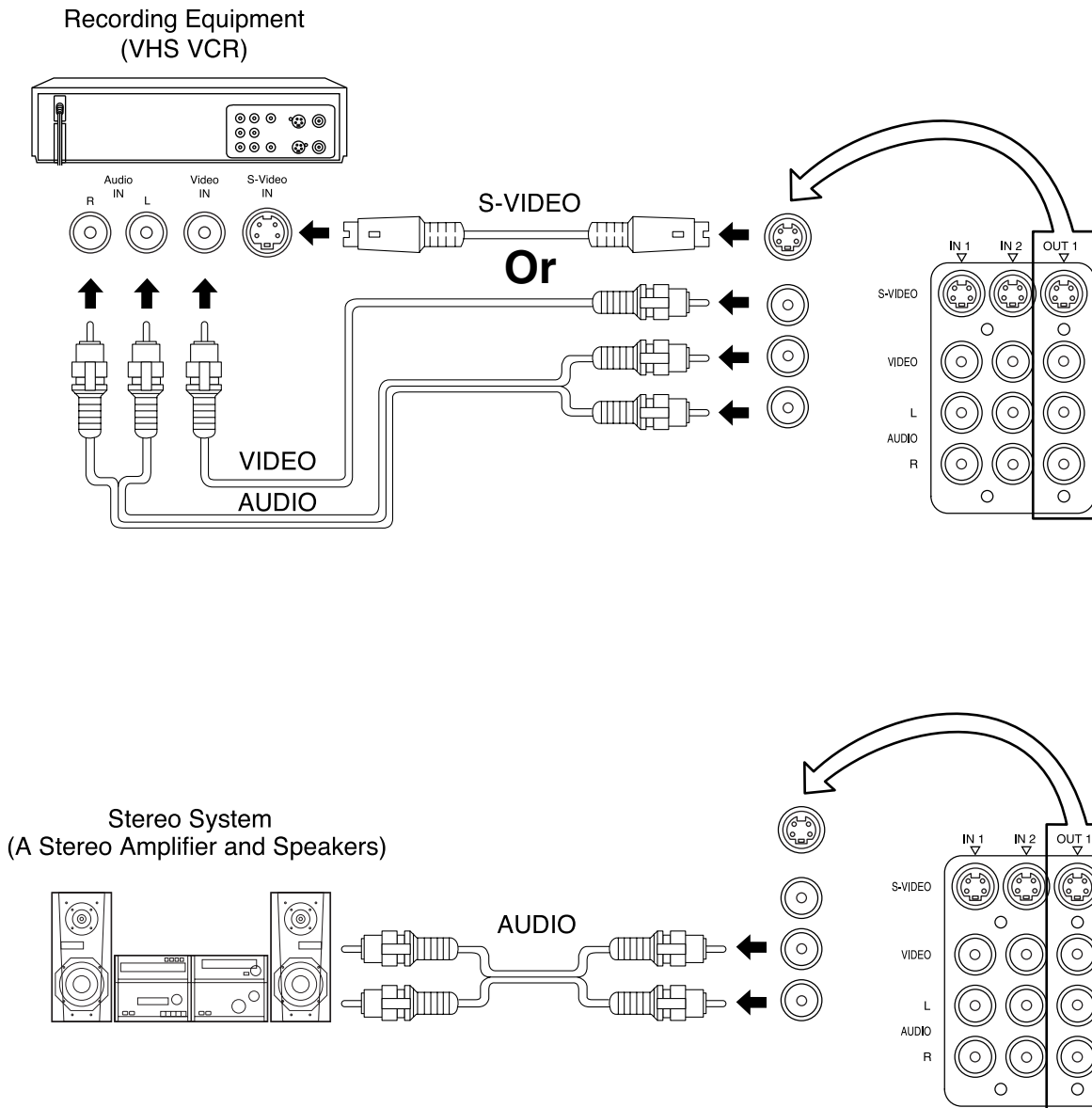

Notes:

- Never connect the VIDEO IN and OUT terminals to the same video recorder, as this could cause incorrect operation.
- Even if TV is in Split or PIP mode, OUT terminals only output the main picture and sound signals. A sub-picture, including channel search, etc., will not be output.
- VIDEO OUT terminals will not output Y, PB, PR, or RGB signals.
- The S-Video OUT terminal outputs the same signal that is input from the S-Video IN terminal.

Installation

How to connect the PC Input Terminals

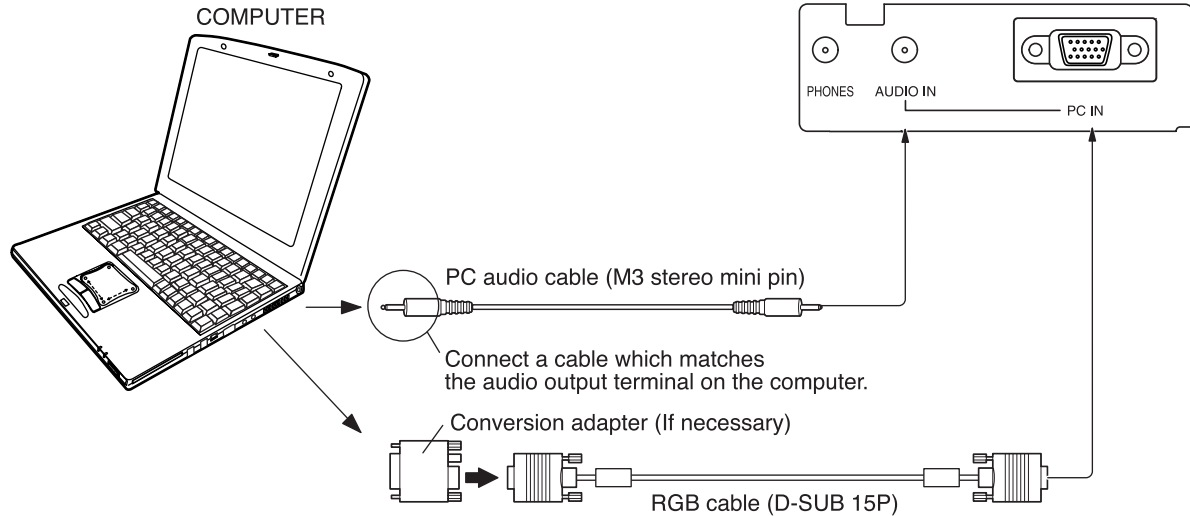

Signal Names for D-SUB 15P Connector

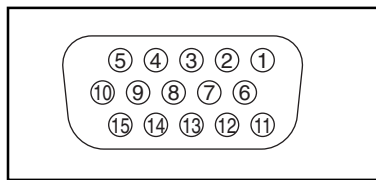

Pin Layout for PC Input Terminal

Pin No.	Signal name	Pin No.	Signal name
1	R	9	NC
2	G	10	Ground
3	B	11	NC
4	NC	12	NC
5	NC	13	HD/CSYNC
6	Ground for R	14	VD
7	Ground for G	15	NC
8	Ground for B		

NC: Not connected

Notes:

- Some PC models cannot be connected to the set. A conversion adapter is required to use the RGB cable (D-SUB 15P) to connect a Macintosh computer to the set. There is no need to use an adapter for computers with PC / AT compatible D-SUB 15P terminal.
- The computer shown in the illustration is for example purposes only. Additional equipment and cables shown are not supplied with this set.
- The picture will become dark if an RGB signal with a vertical scanning frequency of 62 Hz is input. To obtain the optimum picture quality with the projection display, a vertical scanning frequency of 60 Hz is recommended.
- Do not set the horizontal and vertical scanning frequencies for PC signals which are above or below the specified frequency range.
- Select the desired RGB input position by pressing the TV/VIDEO button. (P. 33)

Analog RGB signals that can be input

The table below lists the different types of analog RGB signals that can be input.

If a signal which differs greatly from any of the types listed below is input, the picture image may not be displayed correctly, or a black background may be displayed. At this time, "signal" will flash in the on-screen display for about 5 seconds.

Mode type		Signal data			Information menu display
		No. of dots (H x V)	Horizontal frequency (kHz)	Vertical frequency (Hz)	
Personal Computer Signals	VGA400 (70 Hz)	640 X 400	31.47	70.08	VGA400 70Hz
	VGA480 (60 Hz)	640 X 480	31.47	59.94	VGA 60Hz
	Macintosh 13"	640 X 480	35.00	66.67	MAC 13
	VESA400 (85 Hz)	640 X 400	37.86	85.08	VESA 85Hz
	VESA480 (72 Hz)	640 X 480	37.86	72.81	VGA 72Hz
	VESA480 (75 Hz)	640 X 480	37.50	75.00	VGA 75Hz
	VESA480 (85 Hz)	640 X 480	43.27	85.01	VGA 85Hz
	SVGA (56 Hz)	800 X 600	35.16	56.25	SVGA 56Hz
	SVGA (60 Hz)	800 X 600	37.88	60.32	SVGA 60Hz
	SVGA (72 Hz)	800 X 600	48.08	72.19	SVGA 72Hz
	SVGA (75 Hz)	800 X 600	46.88	75.00	SVGA 75Hz
	SVGA (85 Hz)	800 X 600	53.67	85.06	SVGA 85Hz
	Macintosh 16"	832 X 624	49.73	74.55	MAC 16
	* XGA (60 Hz)	1 024 X 768	48.36	60.00	XGA 60Hz
	* XGA (70 Hz)	1 024 X 768	56.48	70.07	XGA 70Hz
	* XGA (75 Hz)	1 024 X 768	60.02	75.03	XGA 75Hz
	* Macintosh 19"	1 024 X 768	60.24	74.93	MAC 19
* XGA (85 Hz)	1 024 X 768	68.68	85.00	XGA 85Hz	
DTV Format Signals	480 i	664 X 485	15.73	29.97	480 i
	480 p	720 X 483	31.47	59.94	480 p
	720 p	1 280 X 720	45.00	60.00	720 p
	*1080 i	1 920 X 1 080	33.75	30.00	1080 i

Notes:

- Input signals, other than those listed with a * mark, will give you a beautiful, stable picture.
- The front D-SUB15P connector can accept RGB(H-V sync separate) and RGB(sync on green). However, it is not guaranteed to display stable color when using RGB(sync on green).
- When used with an external video processor/scaler, it must have RGB(H-V sync separate) output.

Power ON and OFF

Initial Setup

First, check the connection of the Plug to the Wall Outlet and the Antenna/Cable to the RF in Terminal. (PP. 12-14.)

If using Cable Box, DSS Receiver, or VCR,

- Turn on Cable Box.
- Turn off DSS Receiver, or VCR.



1



Press the POWER button to turn the projection display on. (Refer to page 21 for “Turning the Power ON and OFF”.)

Automatic Channel Setting is performed.

CH AUTO SET PROCEEDING

Note:

To cancel AUTO SET in progress, press the SWAP button.

Case 1

When setup is complete, the lowest channel picture appears.

Case 2

If setup is incomplete, the following screen appears. Check connection of Antenna/Cable to the RF in Terminal, then try Automatic Channel Setting again. (PP. 24, 25)

NO CH FOUND
PLEASE CHECK ANTENNA
CABLE CONNECTION THEN
PRESS ACTION KEY AGAIN

Note:

When the unit is turned on for the first time, Automatic Channel Setting is performed.

Turning the Power ON and OFF

Always be sure to follow the procedure given below to turn the projection display power ON and OFF.

- The lamp cooling fan will continue to operate for approximately 1 minute after the power is turned off. At the same time, the POWER indicator will blink Red.

Do not disconnect the power cord from the power outlet and do not open any circuit breakers while the cooling fan is still operating.

Do not disconnect the power cord from the power outlet while the power indicator blinks Red.

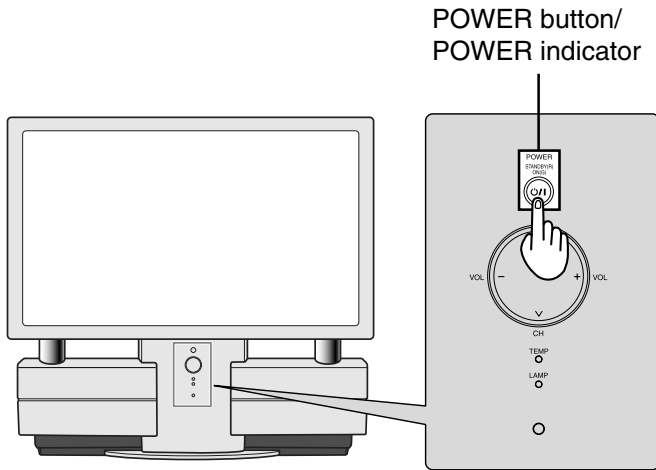

Power ON

Press the POWER button on the projection display or the remote control to turn the power on.

The Power Indicator will become Green and blink for approximately 10 seconds, and then turn solid Green.

Power OFF

Press the POWER button on the projection display or the remote control to turn the power off. Confirming message will appear.

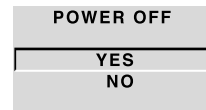

Press the POWER button again.

If the POWER button is accidentally pressed, select NO with the ▲, ▼ buttons, then press the ACTION button.

The Power Indicator will become Red and blink for approximately 1 minute, and then turn solid Red.

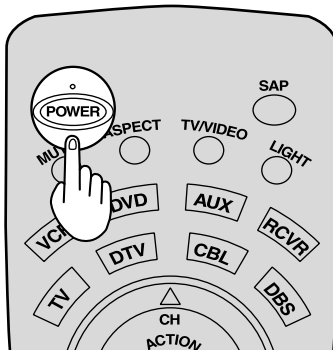

Note:

When the AC Cord is unplugged, the internal cooling fan stops operating. In this case, the lamp will be insufficiently cooled and will take a while to turn ON again.

The Power Indicator

LED	ACTION
Red	Power – OFF (Standby mode)
Red blink	Power – OFF (Now cooling)
Green	Power – ON
Green blink	Power – ON (Preparing to light lamp)

Notes:

- If the POWER button is accidentally turned off during use, after power is turned back on, it may take a short period before the lamp automatically comes on.
- After the unit is turned on, maximum picture brightness will be achieved in 5-10 minutes. This is normal.

Flow Chart of Main menu

1

Pressing the ACTION button displays the MENU screen.

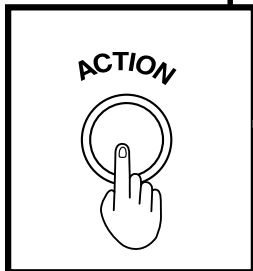

Note:
Depending on the signal being input, some items may or may not be adjustable and some functions may or may not be available.

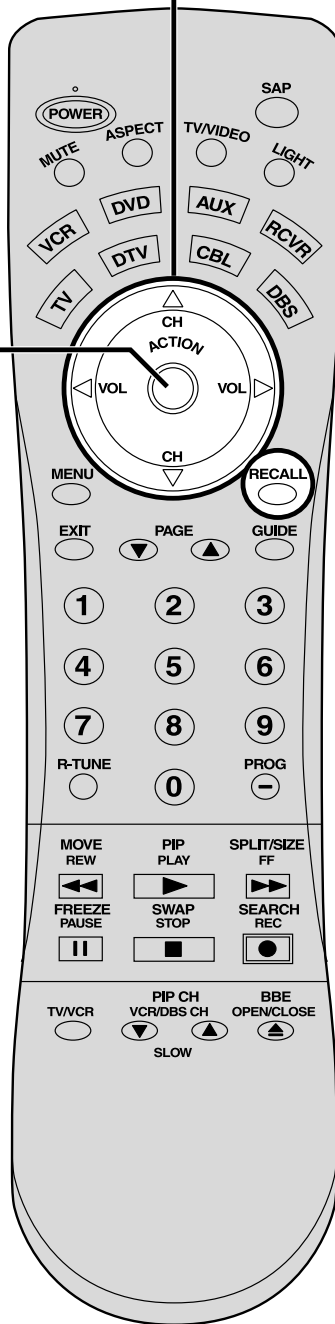

2

Select MENU desired by pushing Left “◀” button or Right “▶” button.

Use the ▲, ▼ buttons to select an item.

Use the ACTION button to set or go to next menu screen.

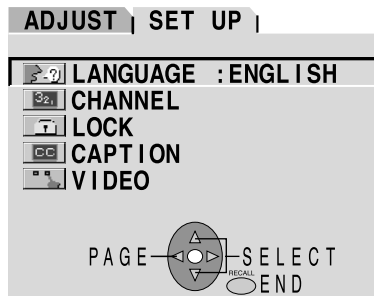
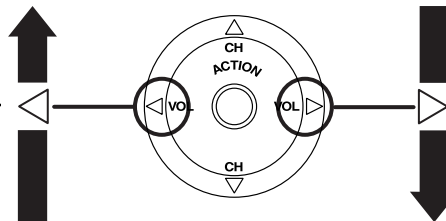
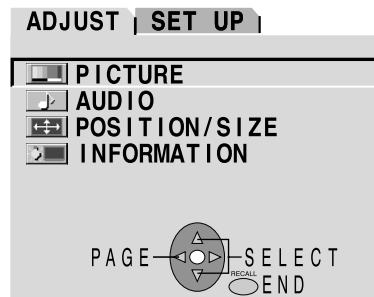
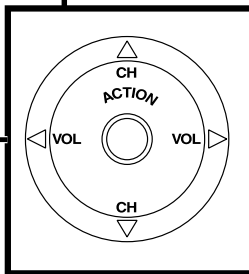

Flow Chart of Main menu

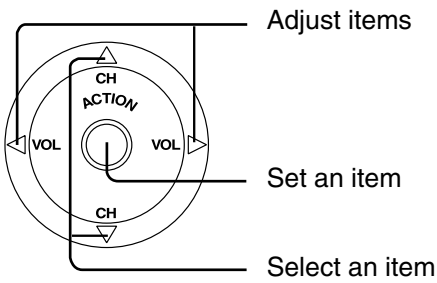

RECALL



Returning to the previous screen

If you press the RECALL button while a menu screen is being displayed, the display will return to the previous screen.

TO PICTURE ADJUST menu

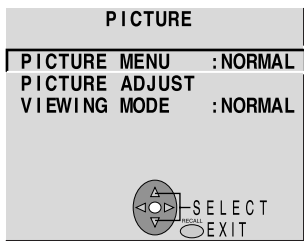

PP. 44, 45

TO AUDIO ADJUST menu

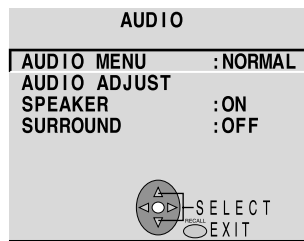

PP. 42, 43

TO POSITION/SIZE ADJUST menu

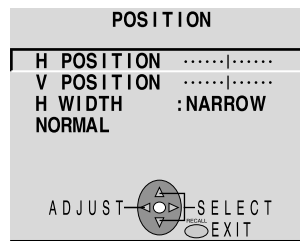

PP. 40, 41

INFORMATION screen

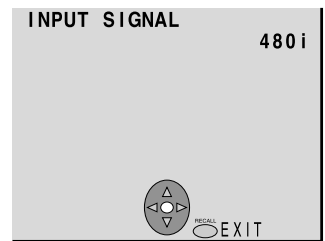

P. 57

TO LANGUAGE selection screen



P. 57

TO CHANNEL menu

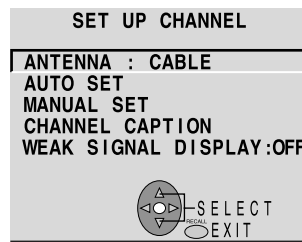

PP. 24-27, 52, 53

TO LOCK selection screen

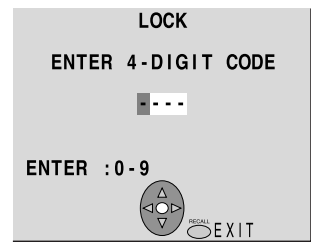

PP. 46-49

TO CAPTION menu



PP. 50, 51

TO VIDEO menu

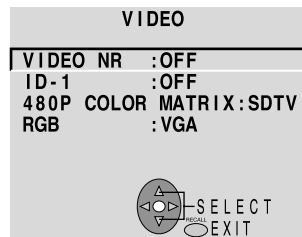

P. 54-56

Tuning channels

Automatic channel setting

Automatically searches and adds receivable channels to memory.



Press the ACTION button to display the MENU screen and select SET UP.

1

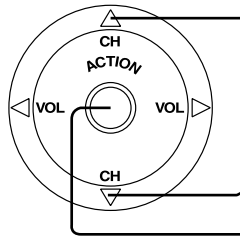

Press to select CHANNEL.

Press to display the CHANNEL.



2

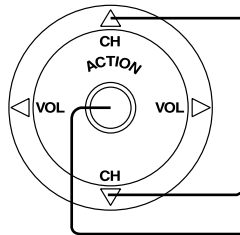

Press to select ANTENNA.

Press to select TV or CABLE.

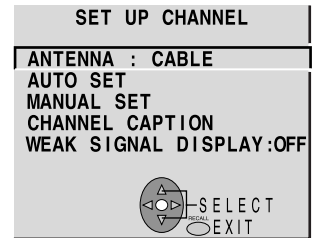

3

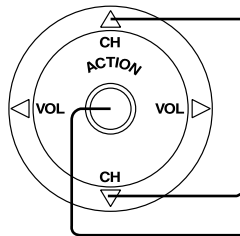

Press to select AUTO SET.

Press to run AUTO SET.

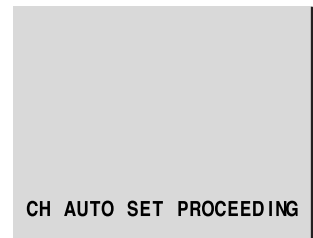
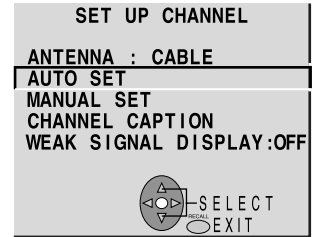

Note:

To cancel AUTO SET in progress, press the SWAP button.

Channels will automatically advance until all channels have been scanned. Channel numbers with a video signal present will be stored in the channel scan memory.

Continued on the next page.

Note:

TV or Cable Tuning mode must be set according to your connections.

4

Case 1

When setup is complete, the lowest channel picture appears.

Case 2

If setup is incomplete, the screen at right appears. Check connection of Antenna/Cable to the RF in Terminal, then try Automatic Channel Setting again.

NO CH FOUND
PLEASE CHECK ANTENNA
CABLE CONNECTION THEN
PRESS ACTION KEY AGAIN

5

RECALL



Press to exit menu.

Notes:

- After AUTO SET is finished, the lowest channel number added will be received.
- Some channels with very weak signals may be locked into memory. If desired, these channels can be deleted manually using the MANUAL SET feature.

Tuning channels

Manual channel setting

Use this setting when changing setting of receiving channels or changing the channel display.

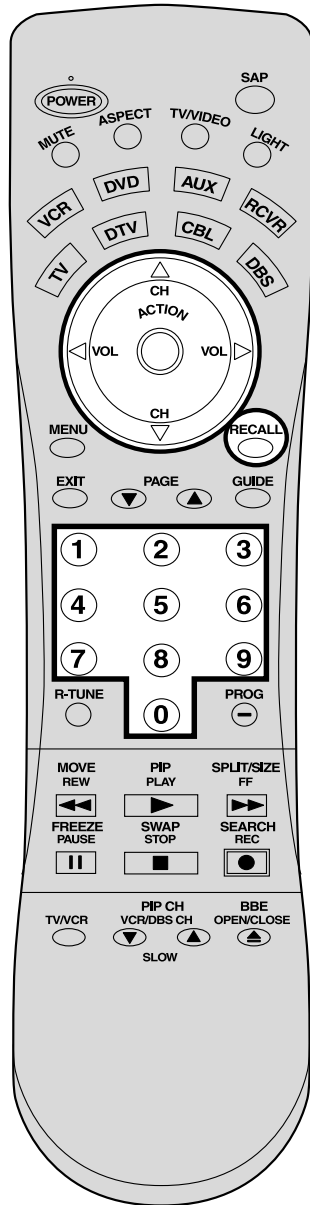

Press the ACTION button to display the MENU screen and select SET UP.

1

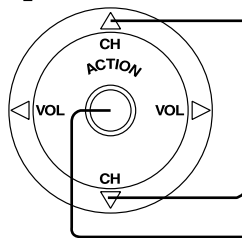

Press to select CHANNEL.

Press to display the CHANNEL.



2

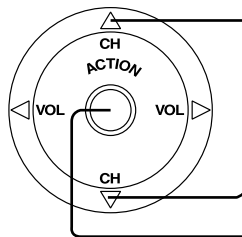

Press to select ANTENNA.

Press to select TV or CABLE.

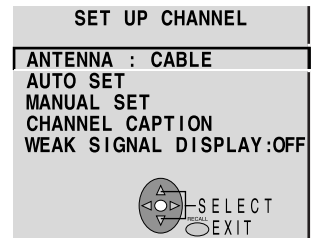

3

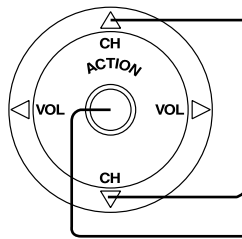

Press to select MANUAL SET.

Press to display the MANUAL SET screen.

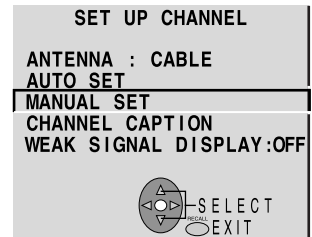

Continued on the next page.

4 To add channel

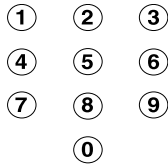

Press to select channel.

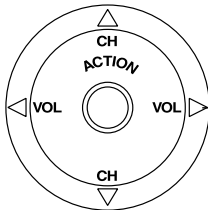

Press to add channels to memory.

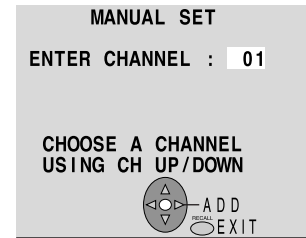

To delete channel

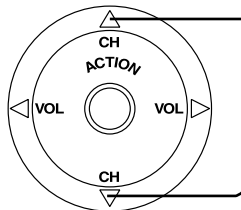

Press to select channel.

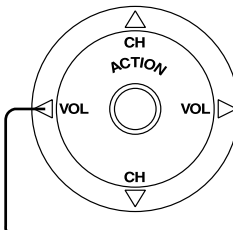

Press to delete channels from memory.

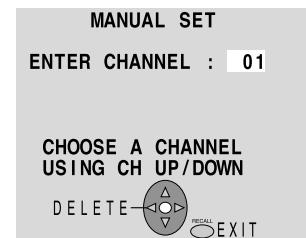

5 Repeat steps 4 to continue adding or deleting channels.

6 **RECALL**
 Press to exit menu.

Note:

Some channels with very weak signals may be locked into memory. If desired, these channels can be deleted manually using the MANUAL SET feature.

Projection display operation

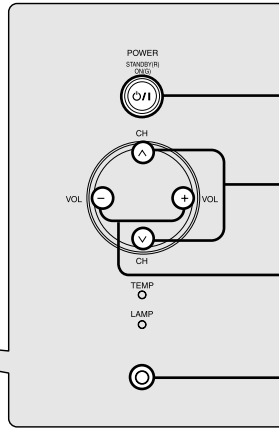
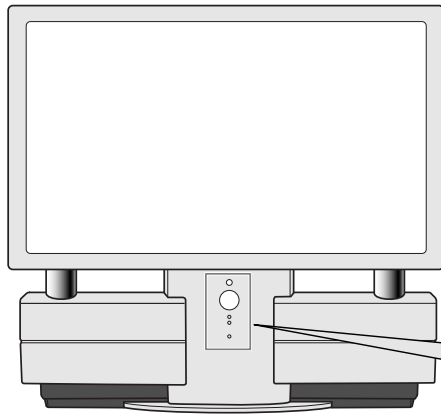

Operation can be done from the projection display.

POWER button/
POWER indicator

Channel up / down buttons

Volume up(+) / down(-) buttons

Remote Control Sensor

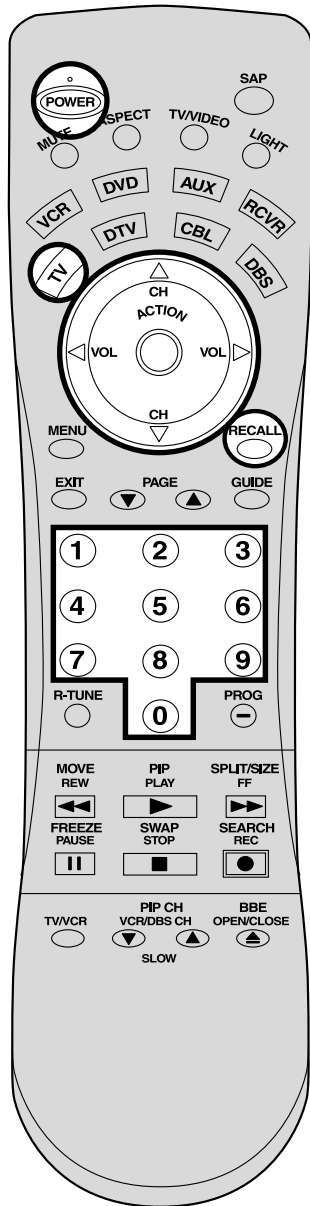

1



Press to operate the projection display with the remote control.

2



Press to turn the projection display on.

3

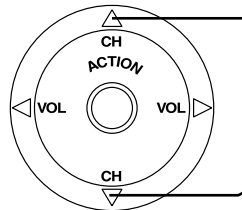

Press to select the desired channel. (or use number keys)

Or

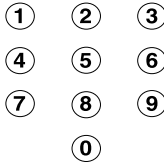

Note:
Refer to "Using the number keys" on the next page.

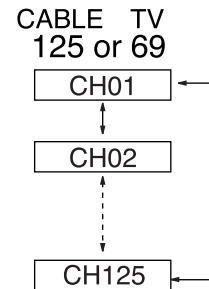

4

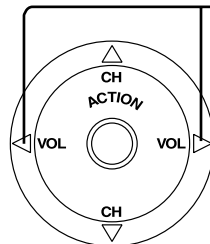

Press to select the desired volume level.



Notes:

- The channel number and volume level are stored even after the projection display is turned off.
- Power consumption can be reduced if the volume level is lowered.

TV status display

RECALL



Press the RECALL button, except when the MENU screen is displayed, to display current TV status information.

Aspect types
(P. 30)

Receivable
broadcast types
(P. 35)

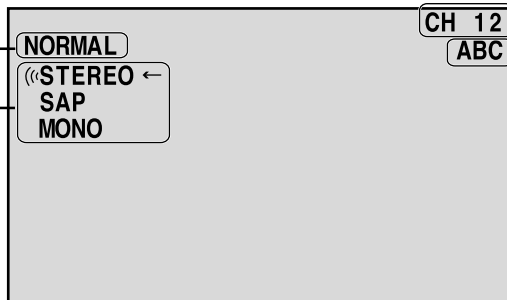

CH 12 — Channel

ABC — Channel caption
(P. 52)

Using the number keys

- ①
- ②
- ③
- ④
- ⑤
- ⑥
- ⑦
- ⑧
- ⑨
- ⑩

When selecting CABLE channels 100 to 125 with the number keys, first press the 1 key, and then enter the remaining two digits.

Example 1: To select channel 125, first press the 1 key, then 2, then 5.

Example 2: To select channel 12, press the 1 key, then 2. Channel 12 appears momentarily.

Example 3: To select channel 8, press the 8 key. Channel 8 appears momentarily.

Using projection display Channel up/down buttons to select input mode

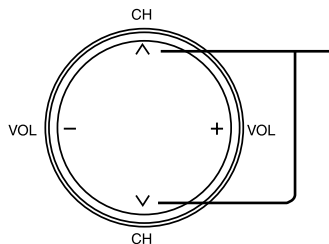

Projection display Channel up/down buttons can also be used to select an outside input as shown right.

* No input mode is displayed for terminals with no equipment connected.

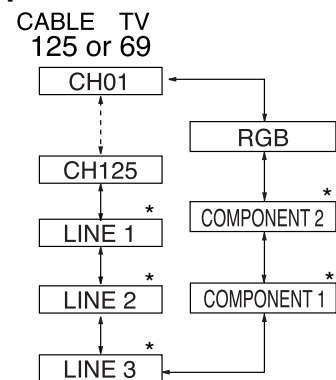

Auto shut off

To extend lamp life, if there is no signal to the set's tuner for 5 minutes, the lamp will shut off automatically.

Invalid operation notice feature

If an invalid operation is attempted, the mark shown right is displayed.

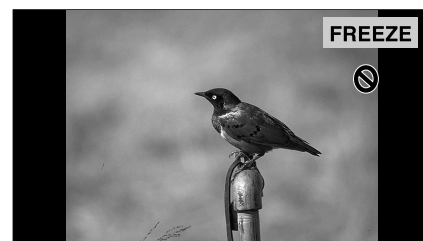

ASPECT Controls

The color monitor will allow you to enjoy viewing the picture at its maximum size, including wide screen cinema format picture.



The aspect mode changes each time the ASPECT button is pressed.

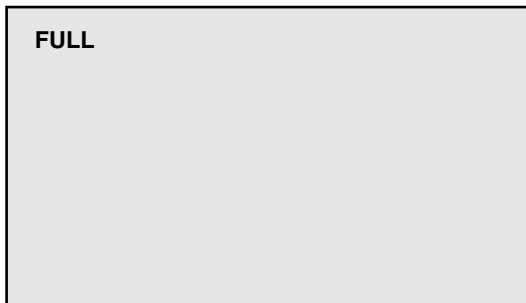
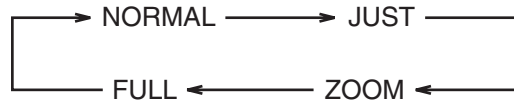

Notes:

- When a 480p signal is being received, the mode switches between NORMAL, ZOOM, and FULL only.
- When a 1080i and 720p signal is being received, the mode is set to FULL, and aspect switching is not possible.
- During PC input, the mode switches between NORMAL, TRUE and FULL only.

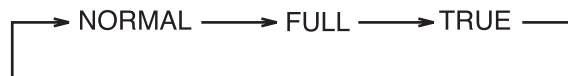

- When XGA and Mac 19 signal is input, the aspect will be NORMAL and FULL only.

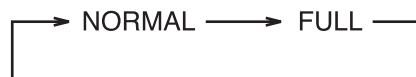

Notes:

- However, if the mode selected does not match the aspect ratio of the input signal, the original picture quality may be affected.
- If using this Projection display in places, such as cafes or hotels, with the aim of displaying programs for a commercial purpose or for public presentation, please note that by using the aspect ratio (16:9) selection function to change the aspect ratio, you may be infringing on the rights of the original copyright owner of that program under copyright protection laws.
- If a normal (4:3) picture is projected in wide screen, distortion may occur around the edges so that part of the picture may no longer be visible. We recommend viewing in 4:3 mode so you can enjoy the picture as it was intended to be seen.

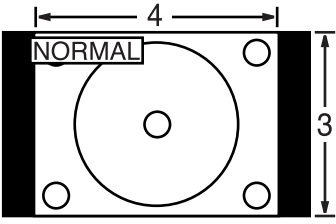
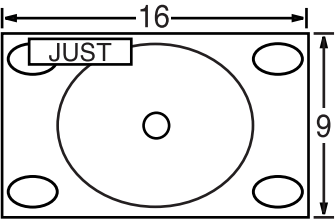
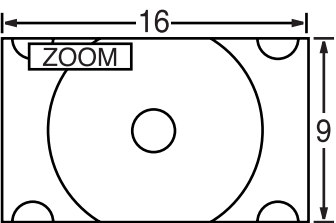
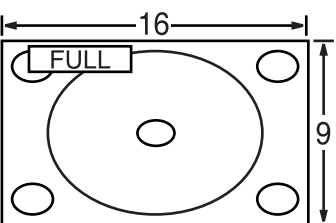
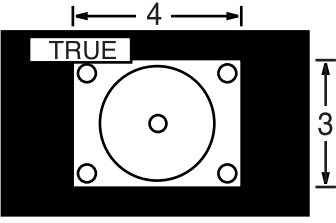
Mode	Picture	Explanation
NORMAL		<p>NORMAL will display a 4:3 picture at its standard 4:3 size.</p>
JUST		<p>JUST mode will display a 4:3 picture at maximum size but with aspect correction applied to the center of the screen so that elongation is only apparent at the left and right edges of the screen. The size of the picture will depend on the original signal.</p>
ZOOM		<p>ZOOM mode magnifies the central section of the picture.</p>
FULL		<p>FULL will display the picture at its maximum size but with sight elongation.</p>
TRUE		<p>You can reduce the image and adjust it to the original image quality. (Except XGA)</p>

Notes:

- The screen size changes if ID-1 is detected. (P. 55)

Searching for the desired channel (Channel search)

Channel search displays each channel, in order, as a paused image. Channels are displayed from the left top to the right bottom in order. When it reaches the right bottom, the next channel is displayed at the left top, overwriting the previously displayed channel.

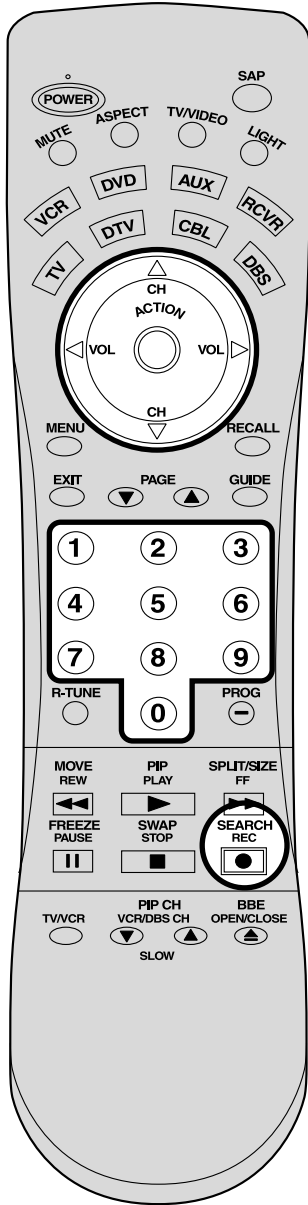

When the SEARCH/REC button is pressed during single screen.

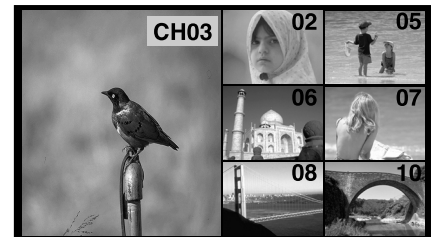

Or



(PC input)

When a channel button is pressed during channel search.

- Number keys:
Example: When 6 is pressed, channel 6 is displayed in single screen.
- Channel up and down buttons:
When ▲ or ▼ button is pressed, the next channel up or down is displayed in single screen.

Ex. Select channel 6

Sound from the left screen is output from the speakers on the projection display set.



Notes:

- To end channel search, press SEARCH/REC.
- While using the PIP feature, Channel search is not available.

Playing peripheral equipment

Confirming connections

A video camera uses the Input 3 terminal on the front of the projection display.

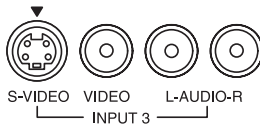
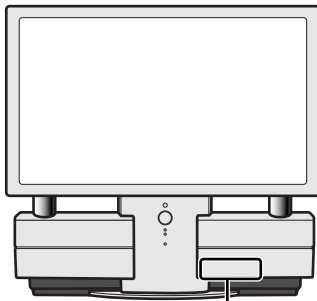

Example: Connect Input 3

Video camera

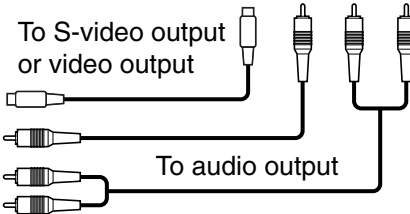
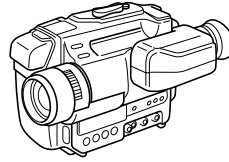

VCR

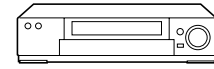

DVD player

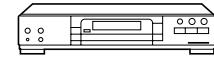

This equipment can also be connected to the rear terminals. See Connections for details.

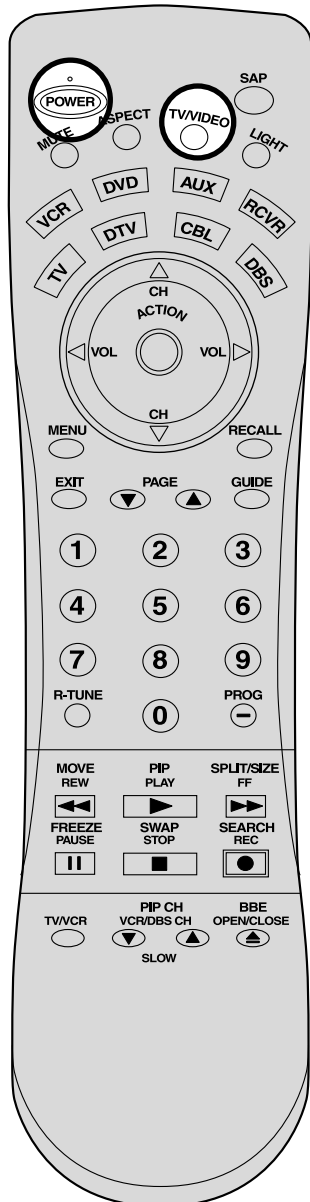

Turning the power on and switching input modes

1



Turn the projection display on.

2



The input mode changes each time this button is pressed.

* No input mode is displayed for terminals with no equipment connected.

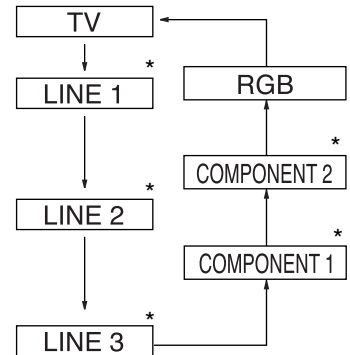

LINE 1:

Signal of source connected to INPUT 1 is displayed.

LINE 2:

Signal of source connected to INPUT 2 is displayed.

LINE 3:

Signal of source connected to INPUT 3 is displayed.

COMPONENT 1:

Signal of source connected to COMPONENT VIDEO INPUT 1 is displayed.

COMPONENT 2:

Signal of source connected to COMPONENT VIDEO INPUT 2 is displayed.

RGB:

Signal of source connected to PC IN is displayed.

3

Operate the connected equipment.

Mute / Freeze / SAP



Sound mute



Useful when answering the phone or receiving unexpected visitors

Press this button to mute the sound. Press again to reactivate sound. Sound is also reactivated when power is turned off or volume level is changed.



Note:

The audio output from AV OUT is not muted.

Freezing pictures

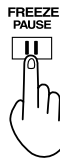

Projection can be switched between a frozen (still) picture and a moving picture each time the FREEZE button on the remote control unit is pressed. Press FREEZE button again to resume motion.

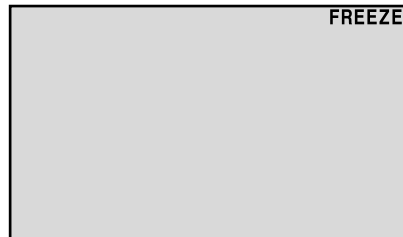

Note:

The video output from AV OUT is not frozen.

Receivable Broadcast Types

The following are possible broadcast types with their accompanying on-screen displays. The signal being received is indicated with a “⊕” mark while the selected audio mode is indicated with an arrow. To change the audio mode for these broadcasts, follow the “Select Audio Mode for TV Viewing” section (below.)

MTS Stereo and SAP broadcast

Multi-channel Television Sound Stereo (main language) and Secondary Audio Program (sub language) broadcasts are both being received simultaneously.

Select the STEREO or SAP audio mode.

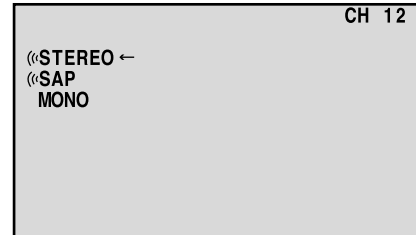

MTS Stereo broadcast

Multi-channel Television Sound Stereo broadcast. Select STEREO audio mode.

- If stereo broadcast is weak and the display flickers, select MONO audio mode for possibly better results.

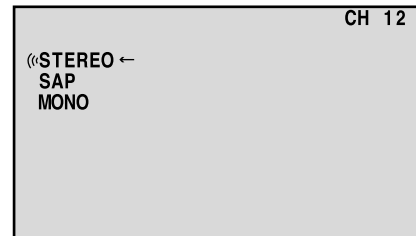

SAP broadcast

Secondary Audio Program (sub language.)

Select SAP audio mode for the sub language.



MONO broadcast

Normal monaural sound broadcast.

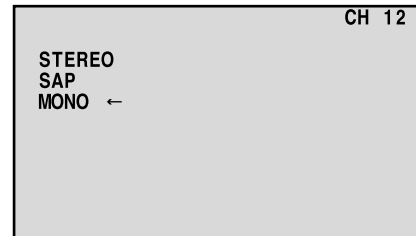

Select Audio Mode for TV Viewing



Press SAP button to select the desired audio mode as described below. (Arrow shows selection.)

- Each press of SAP button will change the audio mode as shown below.
- “SAP” is selected with first press of SAP button.

< Example >

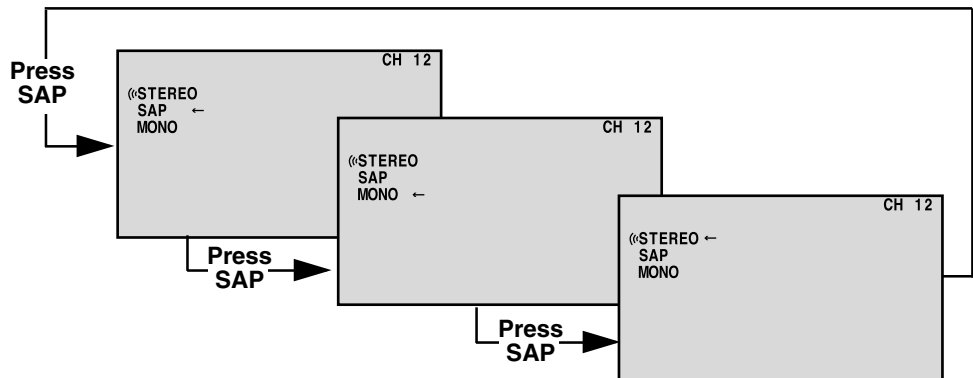

Split screen



Notes:

- Sound from the Left screen is output from the speakers on the projection display set.
- When the screen is split, signals of the Left screen are output from the rear monitor output terminal.
- The left and right screens are processed by individual circuits and, therefore, may slightly vary in image quality.
- Split screen returns to single screen when the projection display is turned off.
- With the Left screen, as with a single screen, you can change the input, change channels, and adjust the volume.
- The right and left screens cannot display the same picture at the same time.
- A split screen which includes an RGB signal from a PC is fixed as SPLIT SCREEN NORMAL (PC input).

Splitting the screen



Press to split.
(The previously selected screen appears on the left.)

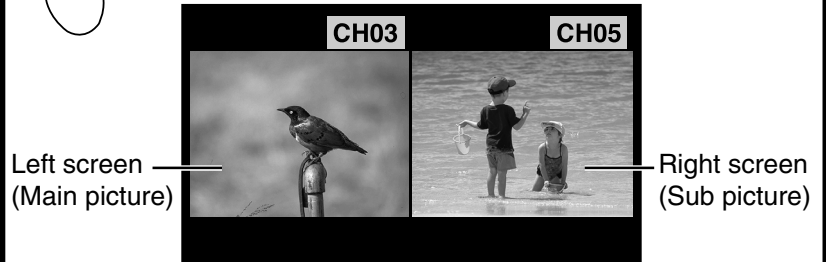

- Returning to one screen.



Press to return.

Selecting the screen mode for split screen.



Press to select modes.

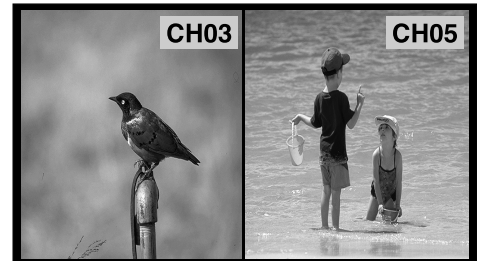

SPLIT SCREEN FULL

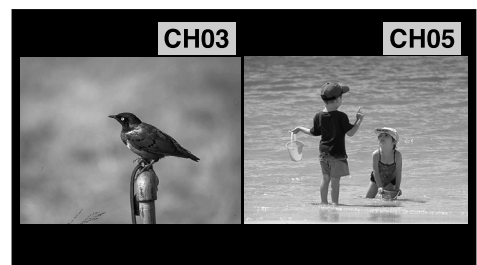

SPLIT SCREEN NORMAL



SPLIT SCREEN NORMAL
(PC input)

Changing the channel of the right screen

1  Press to select the desired channel.
Example:
During SPLIT SCREEN NORMAL.

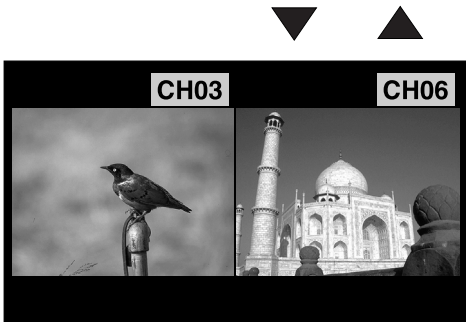
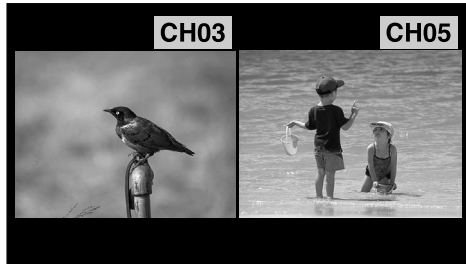

PIP ▲, ▼ buttons can also be used to select an outside input for the right side of the screen.

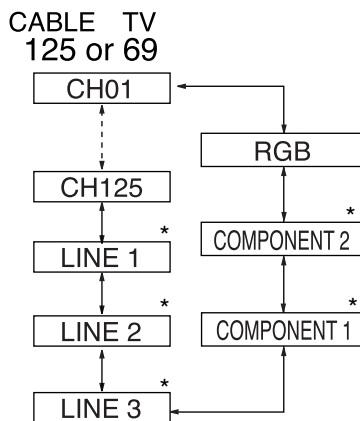

* No input mode is displayed for terminals with no equipment connected.

Note:
When outside input is finished, the lowest registered channel number is displayed. For faster selection, press the SWAP button to change the screen to the left. Then, press the TV/VIDEO button to directly change the input. Finally, press SWAP button again to change the screen back to the right.

Swapping left and right screens

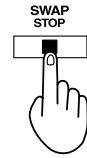
 Press to swap.

Example:
During SPLIT SCREEN NORMAL.

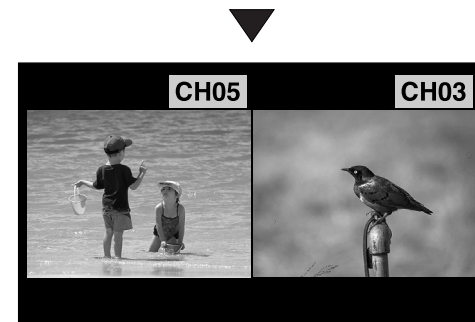
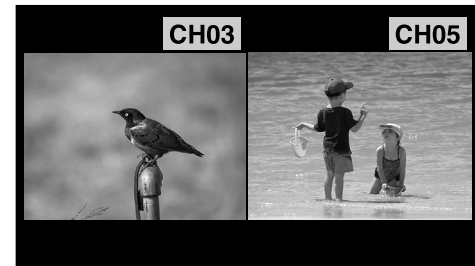

Example:
During SPLIT SCREEN NORMAL
(PC input)



Note:
Picture quality may change according to the combination of signals input to the left and right screens.

Picture in Picture (PIP) Screen

You can view two pictures simultaneously using two tuners and picture in picture (PIP) display function.

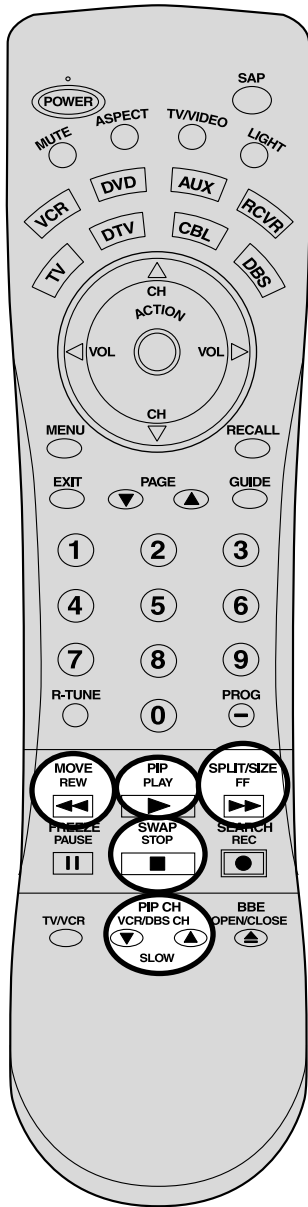

Display PIP screen

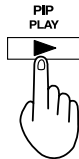

Press to split
(The previously selected screen appears on the Main.)



Main screen
(Main picture)

PIP screen
(Sub picture)

- Returning to one screen.

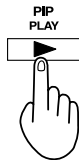

Press to return.

Notes:

- Sound from the Main screen is output from the speakers on the projection display set.
- In PIP mode, the Main screen signal is output from the rear monitor output terminal.
- Because Main and PIP screens are processed by individual circuits, image quality may vary slightly.
- PIP mode returns to single screen when the projection display is turned off.
- The Main and PIP screens cannot display the same picture at the same time.
- An RGB signal cannot be displayed on a PIP screen or a Main screen.
- A component signal cannot be displayed on a PIP screen. Thus, when a component signal is displayed on the Main screen, the SWAP button becomes invalid.
- With the Main screen, as with a single screen, you can change the input, change channels, and adjust the volume.

Picture in Picture (PIP) Screen

Changing the channel of the PIP screen



Press to select the desired channel.

Example:
During Main screen NORMAL.

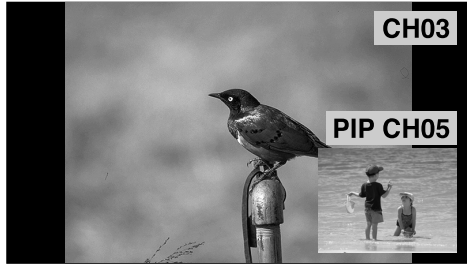

Note:

PIP ▲, ▼ buttons can also be used to select an outside input for the PIP screen.

Swapping Main and PIP screens

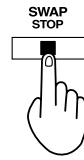

Press to swap.

Example:
During Main screen NORMAL.



Selecting the screen size for PIP screen

You can choose PIP screen size of 3 magnifications.



Press repeatedly to select PIP screen size.

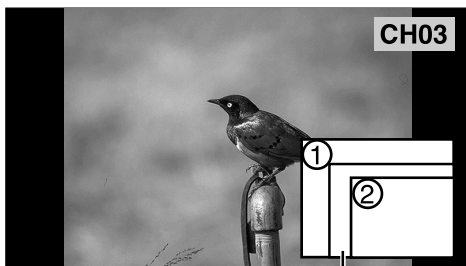
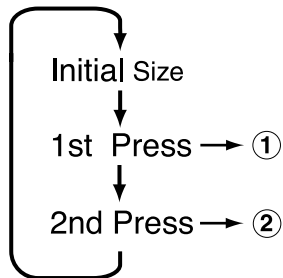

Initial size

Note:

The last size chosen is saved and will not be erased even if the power is turned off.

Move PIP screen

You can move the PIP screen to four positions.



Press repeatedly to select PIP position.

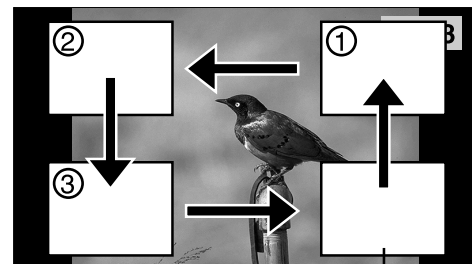
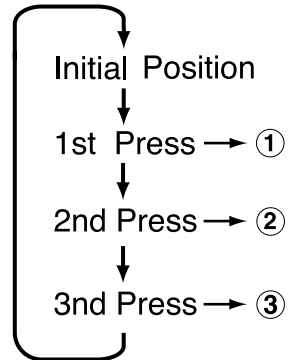

Initial position

Note:

The last position chosen is saved and will not be erased even if the power is turned off.

Adjusting screen position and size

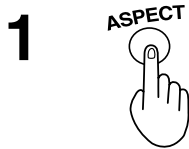
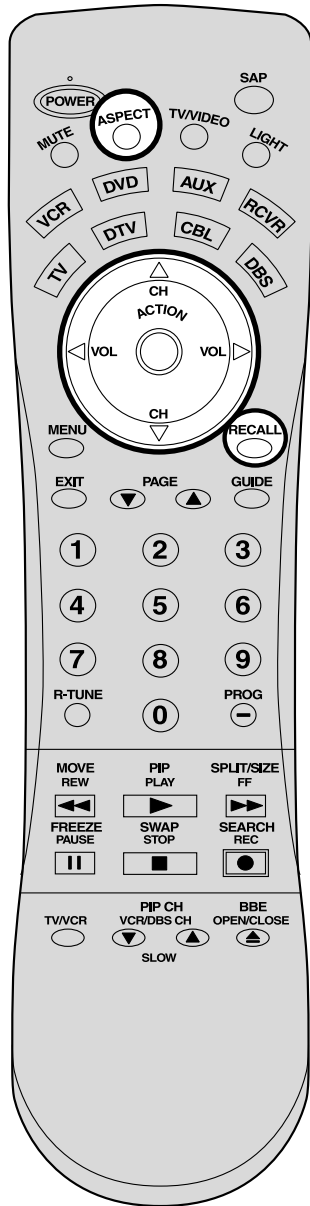

Press to select the screen mode.

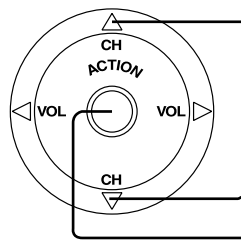
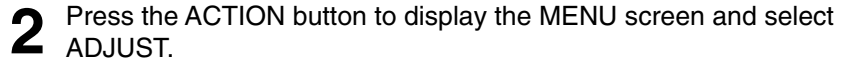

Press to select POSITION/SIZE.

Press to display POSITION/SIZE.

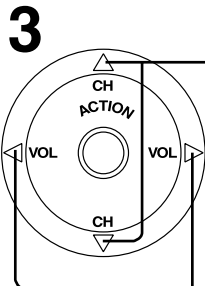
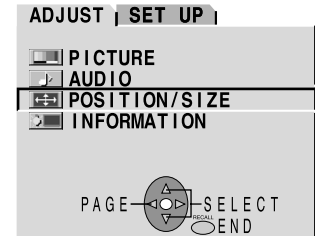

Press to select the menu to set each item.

Press to adjust POSITION/SIZE.

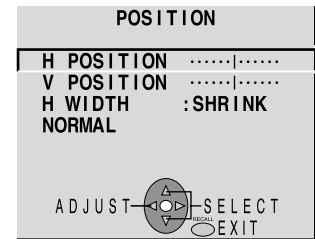

NORMAL is displayed at default.

JUST mode

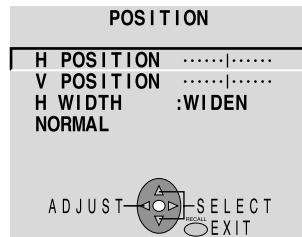

NORMAL mode

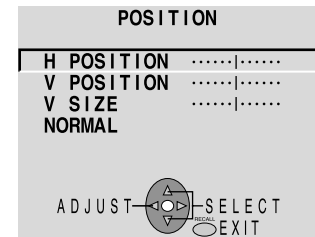

ZOOM mode

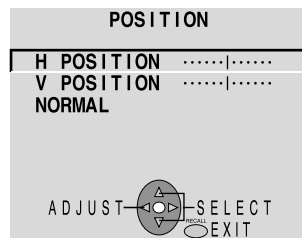

FULL mode

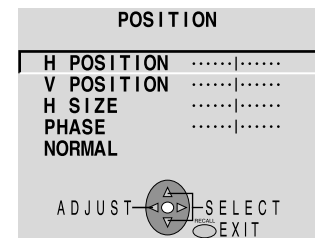

PC input



Press to exit menu.

Adjusting screen position and size

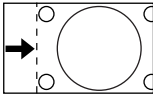
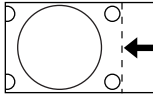
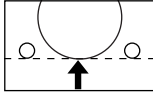
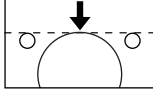
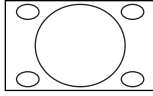
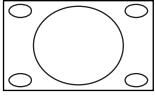
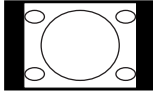
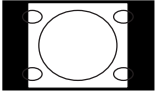
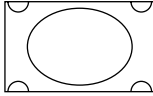
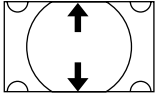
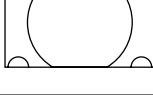
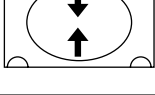
Adjustment item	Button	Adjustment Details	Note
H Position	Press ► button.	The image moves to the right. 	
	Press ◀ button.	The image moves to the left. 	
V Position	Press ► button.	The image moves up. 	
	Press ◀ button.	The image moves down. 	
H WIDTH	Press ACTION button.	If noise appears on the ends of the image in SHRINK, switch to ENLARGE.  	Only JUST mode
		If noise appears on the ends of the image in WIDEN, switch to NARROW.  	Only NORMAL mode (Except PC input)
V SIZE	Press ► button.	Press to enlarge image vertically 	Only ZOOM mode
	Press ◀ button.	Press to shrink image vertically 	
H SIZE	Press ► button.	Press to enlarge image horizontally 	PC input
	Press ◀ button.	Press to shrink image horizontally 	
PHASE	Press ► button. Press ◀ button.	Adjust in order to remove any picture interference or contour blurring which may occur in computer images.	PC input

Notes:

- This projection display is equipped with various screen modes. If a screen mode with a different aspect from the broadcast program is selected, image will appear differently. Select the proper screen mode with this in mind.
- Be careful when using this projection display for commercial purposes or for public use, such as in cafes and hotels.
- Shrinking and enlarging images by using screen mode switching function (zoom, etc.) may violate copyright laws.
- Images displayed on a wide screen TV will be cut off or distorted at the edges, when viewing normal aspect images of 4:3 in ZOOM, JUST or FULL mode. Display in NORMAL mode to view the original image intended by the producer.
- For 1080i and 720p input images, screen size cannot be adjusted.
- The adjusted setting will be kept even when the projection display is turned off.
- The signals output from the monitor output terminal on the back of the projection display is not affected when the screen size and position is adjusted.

Audio Adjustments

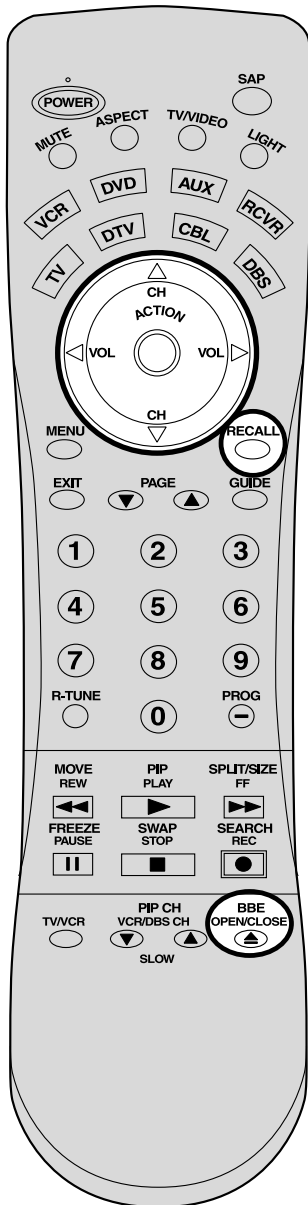

Press the ACTION button to display the MENU screen and select ADJUST.

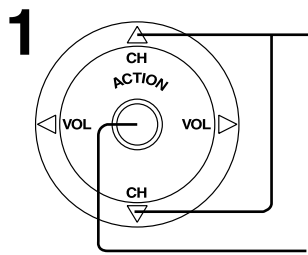

Press to select AUDIO.

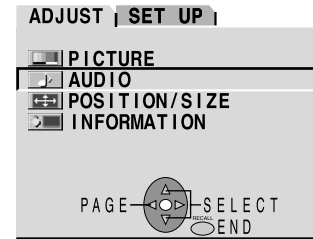

Press to display AUDIO screen.

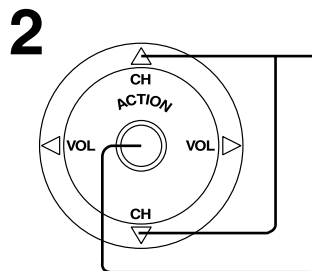

Press to select the menu to set each item.

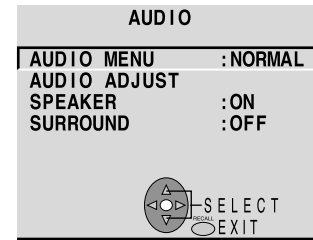

Press to set each item.

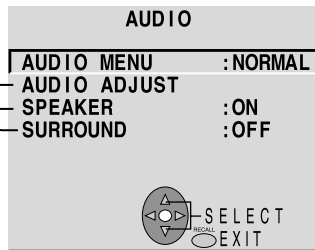

You can hear deeper, 3D audio using just the unit's two front speakers. Surround sound effect is not available for normal (mono) broadcasts.

You can turn off the unit speaker when it is connected to external audio equipment.

See next page

NORMAL Emits the original sound. (Factory setting)

AUTO The sound level is automatically adjusted to suit the program source.

CINEMA Sound suited to movies.

MUSIC Sound suited to music.

SPEECH Sound suited to dialogue.



Press to exit menu.

Notes:

- Sound signals are output from the rear AUDIO OUT terminal.
- When volume is adjusted or the mute button is pressed from the remote control, a message will be displayed.

1 Repeat step 1 on page 42.

2 Press to select AUDIO ADJUST

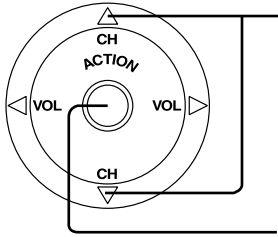

Press to display AUDIO ADJUST screen.

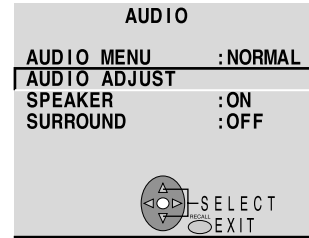

3 Press to select the menu to set each item.

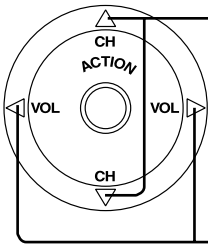

Adjust the desired level by listening to the sound.

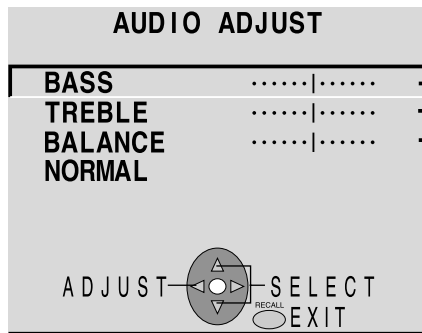
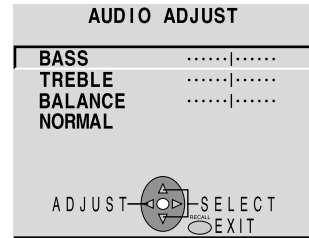

NORMAL is displayed at default.

BASS
Adjusts low sounds

TREBLE
Adjusts high sounds

BALANCE
Adjusts left and right volumes

4 **RECALL** Press to exit menu.



Using BBE

BBE
OPEN/CLOSE



Press this button to turn the BBE sound feature On or Off.

BBE sound technology enhances speech intelligibility and restores the dynamic range of musical passages to provide outstanding natural sound.

Note:
If BBE is ON, SURROUND cannot be selected.

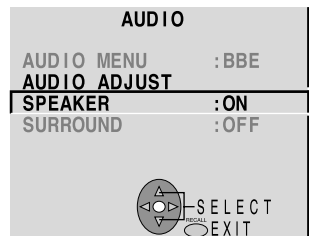

Note:
If the AUDIO MENU is set to AUTO, or if BBE is ON, BASS and TREBLE cannot be adjusted.

Picture Adjustments

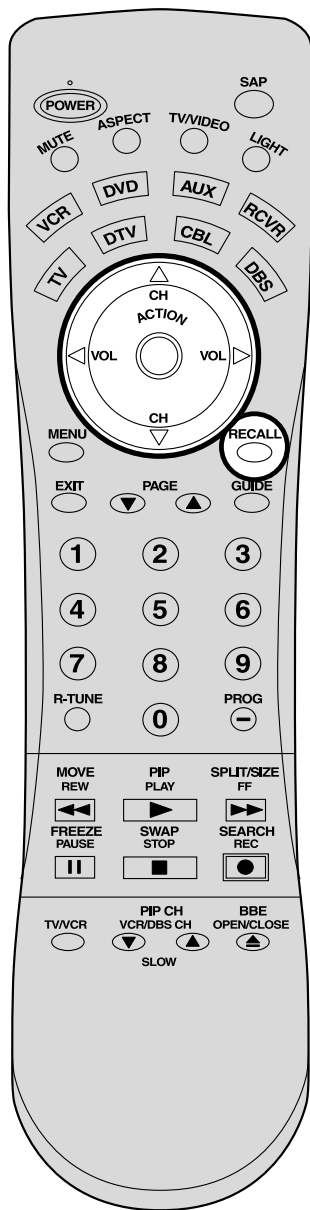

Press the ACTION button to display the MENU screen and select ADJUST.

1

Press to select PICTURE.

Press to display PICTURE screen.

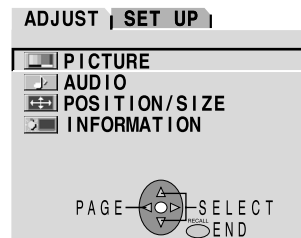

2

Press to select the menu to set each item.

Press to set each item.

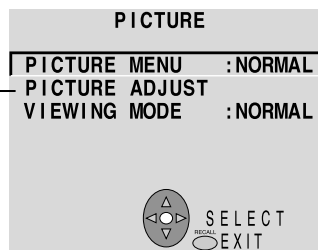
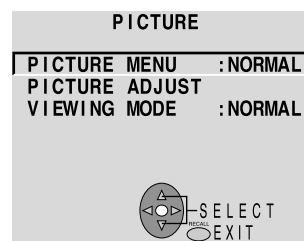

NORMAL

Displays unaltered image.

CINEMA

Ideal for movies.

During PC input, picture menu changes to NORMAL.

See next page

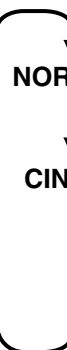

NORMAL Factory setting.

CINEMA When the brightness is reduced, you can enjoy an easy-on-the-eyes picture as well as extend the life of the LCD panel. When high brightness is not required, we recommend using the CINEMA setting. This is also the best mode for DVD movie and HD picture enjoyment.

Note:

There is little change when PICTURE is increased with a bright picture or reduced with a dark picture.

3

RECALL

Press to exit menu.

1 Repeat step 1 on page 44.

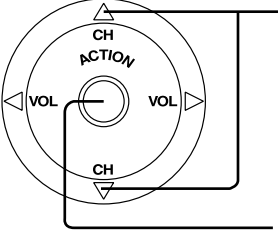
2  Press to select PICTURE ADJUST.

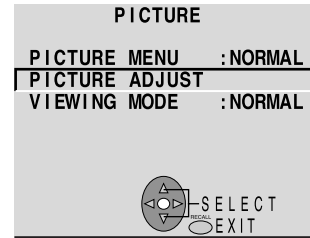

Press to display PICTURE ADJUST screen.

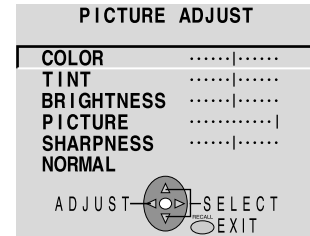

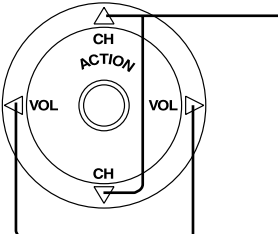
3  Press to select the menu to set each item.

Adjust the desired level by looking at the picture behind the menu.

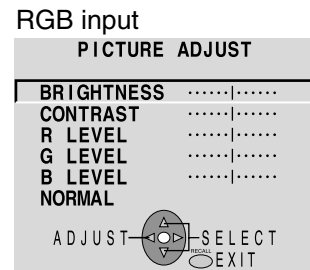

NORMAL is displayed at default.

4  Press to exit menu.

Adjustment item	Button	Adjustment Details	Remarks
COLOR	Press ► button.	The color becomes deeper.	Except RGB
	Press ◀ button.	The color becomes paler.	
TINT	Press ► button.	Flesh tones become greenish.	Except RGB
	Press ◀ button.	Flesh tones become reddish.	
BRIGHTNESS	Press ► button.	The screen becomes brighter.	
	Press ◀ button.	The screen becomes darker.	
PICTURE	Press ► button.	Picture intensity becomes stronger as both contrast and color levels are adjusted.	Except RGB
	Press ◀ button.	Picture intensity becomes weaker as both contrast and color levels are adjusted.	
SHARPNESS	Press ► button.	The picture quality becomes sharper.	Except RGB
	Press ◀ button.	The picture quality becomes softer.	
CONTRAST	Press ► button.	Only the Highlights of the image become brighter, adding Contrast.	RGB only
	Press ◀ button.	The Highlights become less bright, diminishing Contrast.	
R LEVEL	Press ► button.	The red component becomes stronger.	RGB only
	Press ◀ button.	The red component becomes weaker.	
G LEVEL	Press ► button.	The green component becomes stronger.	
	Press ◀ button.	The green component becomes weaker.	
B LEVEL	Press ► button.	The blue component becomes stronger.	
	Press ◀ button.	The blue component becomes weaker.	

Lock Feature

This unit has a built-in V-Chip Control which allows you to block unwanted TV usage based on US MOVIES and US TV PROGRAMS ratings.

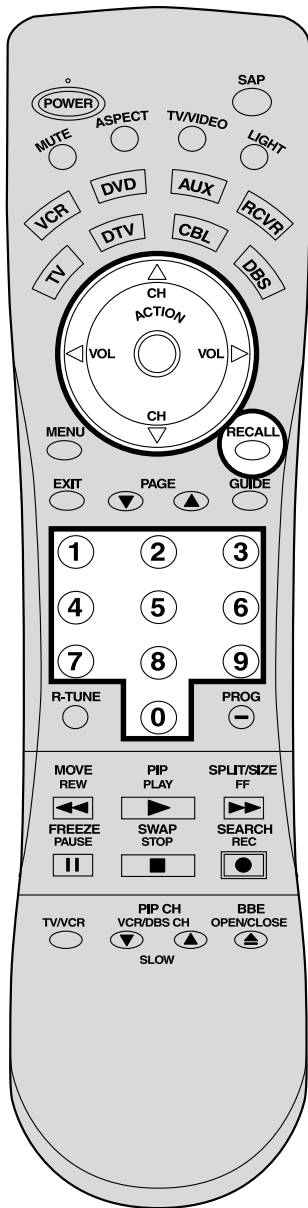

Enter Secret Code

A 4-digit code must be entered to view a blocked program or change rating settings. Press the ACTION button to display the MENU screen and select SET UP.

1

Press to select LOCK.

Press to display the LOCK screen.



2

Press number keys to enter your secret code.

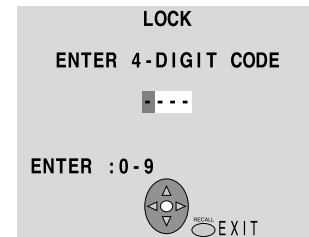

Press to save 4-digit code.

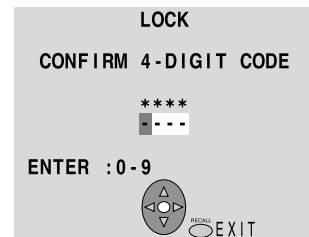

Changing your secret code

- You will need your current code. Press "◀" to clear current code. Repeat step 2 to enter new code.

Note:

- Use a code that is easy to remember and record it in a safe place.

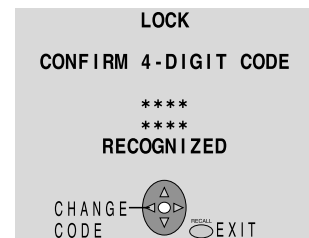

3

Press to exit menu.

Or,

Press to display LOCK menu for rating screen and go to page 47 (US MOVIES Ratings), or page 48 (US TV PROGRAMS Ratings).

Notes:

- Once ratings are set, restricted tapes or programs cannot be accessed unless the secret code is entered.
- If you forget your secret code, refer to "Reset User's Memory Functions" on page 49.

Setup US MOVIES Ratings

Perform "Enter Secret Code" step 1 on page 46.

- 1**
- | | | |
|---|---|---|
| ① | ② | ③ |
| ④ | ⑤ | ⑥ |
| ⑦ | ⑧ | ⑨ |
| ⑩ | | |

Press number keys to enter your secret code.

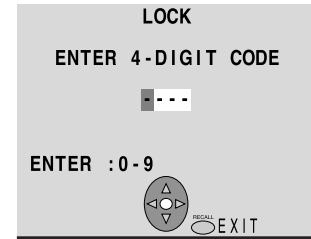

+

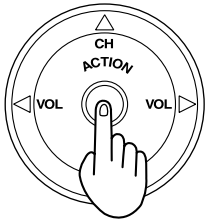

Press to set.

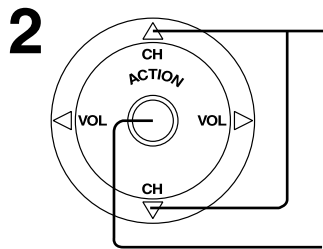

Press to select US MOVIES.

ON : V-Chip Control is activated.
OFF : V-Chip Control is deactivated.

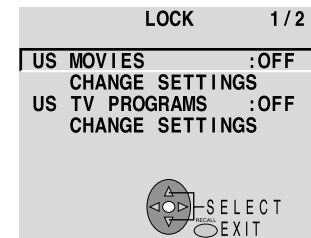

Press to set

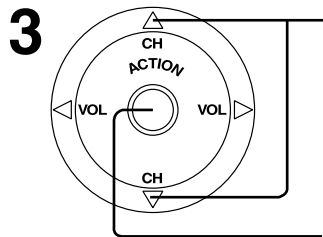

Press to select CHANGE SETTINGS.

Press to display the CHANGE SETTINGS screen.

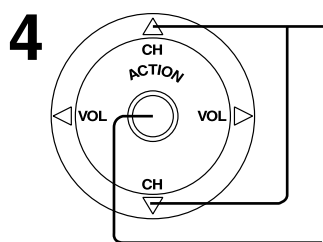
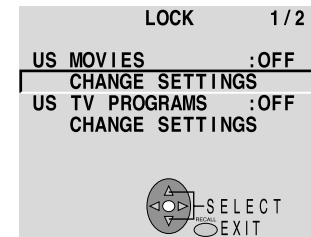

Press to select VIEW NR PROGRAMS?.

VIEW NR (Not Rated) PROGRAMS
NO: Cannot view NR programs.
YES: Can view NR programs.

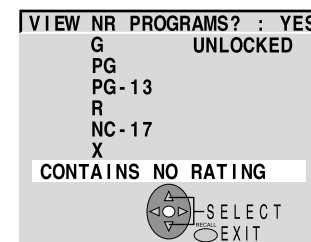

Press to set "YES" or "NO".

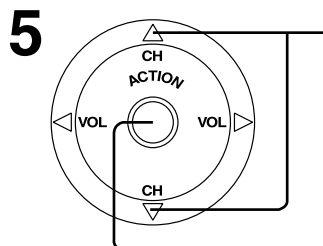

Press to select ratings to be blocked. (P. 49.)

Note:
Ratings highlighted in Red will be blocked while those not highlighted (black letters) will not be blocked.

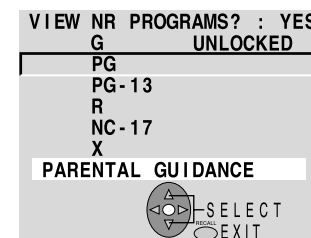

Press to set.

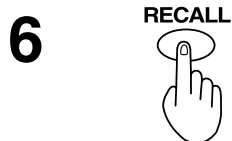

Press to exit menu.

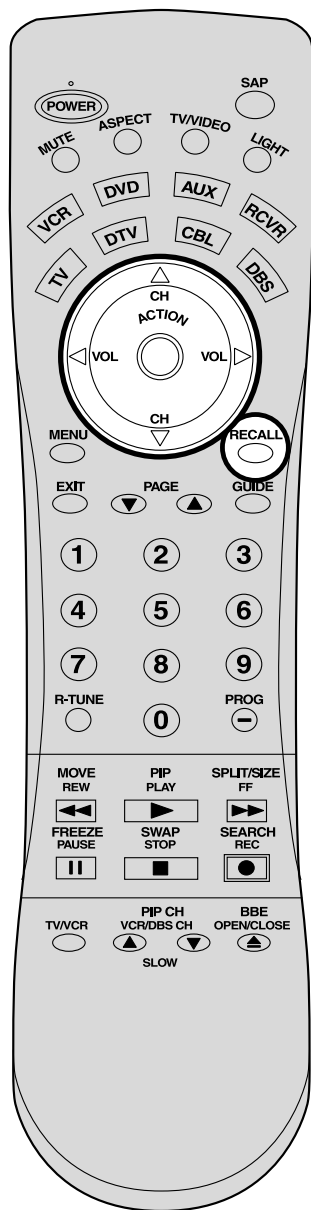

Setup US TV PROGRAMS Ratings

Perform "US MOVIES Ratings" step 1 on page 47.

1  Press to select US TV PROGRAMS.

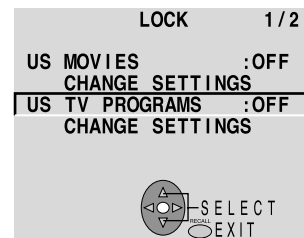

Press to set.

ON : V-Chip Control is activated.
OFF : V-Chip Control is deactivated.

2  Press to select CHANGE SETTINGS.

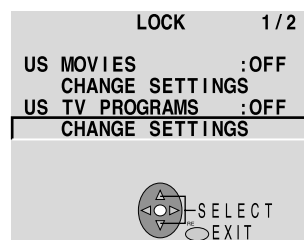

Press to display the CHANGE SETTINGS screen.

3  Press to select VIEW NR PROGRAMS?.

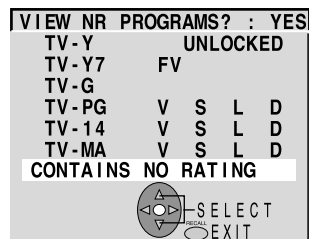

Press to set "YES" or "NO".

VIEW NR (Not Rated) PROGRAMS

NO: Cannot view NR programs.
YES: Can view NR programs.

4  Press to select ratings to be blocked. (P. 49.)

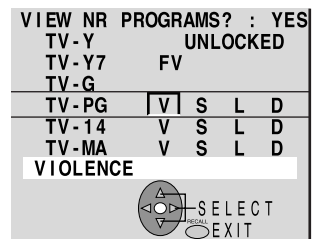

Press to set.

You may select from standard TV ratings (chart 1), or customize to a specific content rating (chart 2.)

Note:

Ratings highlighted in Red will be blocked while those not highlighted (black letters) will not be blocked.

5  Press to exit menu.

US MOVIES RATINGS:

G	GENERAL AUDIENCE: All ages admitted.
PG	PARENTAL GUIDANCE SUGGESTED: Some material may not be suitable for children.
PG-13	PARENTS CAUTIONED: Some material may be inappropriate for children under 13.
R	RESTRICTED Children under 17 must be accompanied by a parent or adult.
NC-17	OVER AGE 17 ONLY: No one 17 and under admitted
X	ADULTS ONLY:

US TV PROGRAMS RATINGS: Chart 1

TV-Y	FOR ALL CHILDREN: Content specifically geared to young viewers ages 2-6.
TV-Y7	FOR AGE 7 AND OLDER: May contain mild physical or comedic violence which may frighten children under 7.
TV-G	GENERAL AUDIENCE: Contains little or no violence, strong language, or sexual dialogue or situations.
TV-PG	PARENTAL GUIDANCE: May contain infrequent coarse language, limited violence, some suggestive sexual dialogue and situations.
TV-14	PARENTS CAUTIONED: May contain sophisticated themes, sexual situations, strong language, and more intense violence.
TV-MA	MATURE AUDIENCE: May contain mature themes, profane language, graphic violence, and sexual situations.

US TV PROGRAMS RATINGS: Chart 2

FV	Fantasy Violence
V	Violence
S	Sexual Situations
L	Adult Language
D	Sexually Suggestive Dialogue

Blocking Message

<When V-Chip Control is activated>

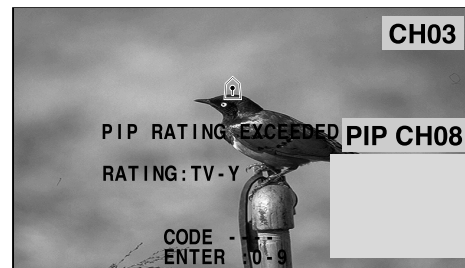
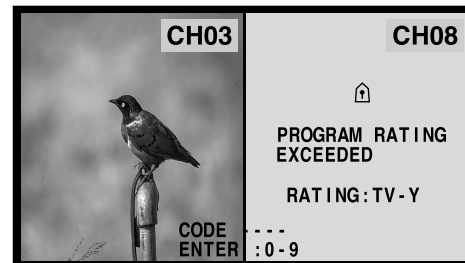
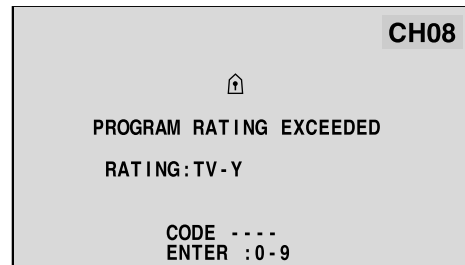

Temporarily deactivate V-Chip control

Enter your secret code in the blocking message screen.

- V-Chip control is reactivated when power is turned off or power failure occurs.

Reset User's Memory Functions

Use when moving unit to a new location, or if the secret code is forgotten.

While the OSD at right is displayed, press the VOL - button on the Projection display and ACTION button on the Remote control at same time for more than 5 seconds. When reset is finished, power shuts off automatically.

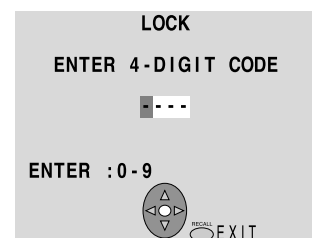

Closed Captions

This receiver has a built in decoder that provides a visual depiction of the audio portion of a television program in the form of written words across the screen (white or colored letters on a black background). It allows the viewer to read the dialogue of a television program or other information.

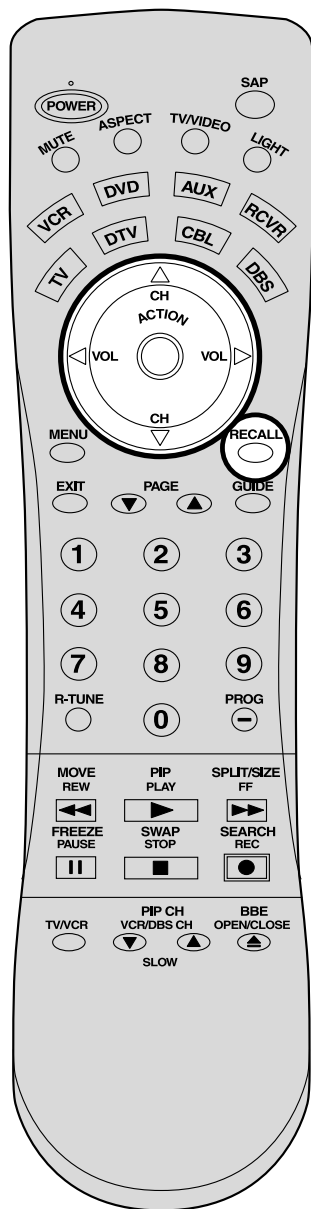

CAPTION MODE

Activates the On-Screen Closed Caption feature. When activated this feature will remain on until OFF is selected in this menu.

Press the ACTION button to display the MENU screen and select SET UP.

1

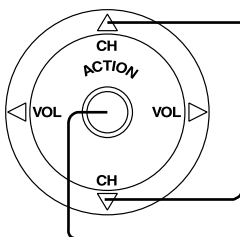

Press to select CAPTION.

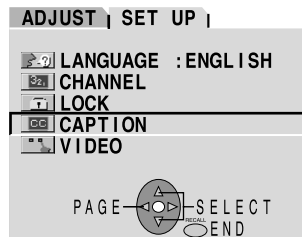

Press to display the CAPTION screen.

2

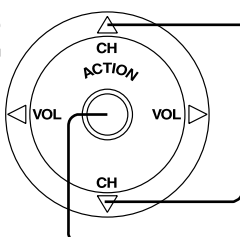

Press to select CAPTION MODE.

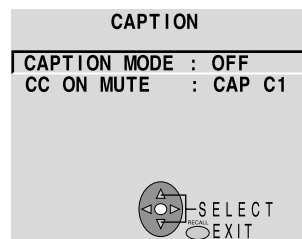

Press repeatedly to select CAPTION MODE.



Closed Caption Modes from which to Choose

Caption Mode: CAP C1 or C2

A narration of selected TV programs is displayed. Check TV program listings for C. C. (Closed Caption) broadcasts.

Caption Mode: TEXT C1 or C2

The lower half of the screen will be blocked out. When the TV station broadcasts information, such as program listings, it will appear in this space.

Caption Mode: OFF

Closed Caption /Text narration will not be displayed.

Note:

The closed caption or text signal may be broadcast over C1, C2, or both. Also, text contents can vary so you may wish to try different settings.

3 **RECALL**



Press to exit menu.

CC ON MUTE

Activates the On-Screen Closed Caption feature, when the MUTE button on the Remote Control is pressed. To deactivate, press the MUTE button again.

Note:

This feature functions when the Closed Caption Mode is in the "OFF" position. The program being viewed must be broadcast with Closed Caption.

Press the ACTION button to display the MENU screen and select SET UP.

1

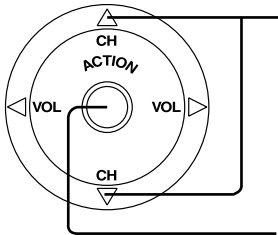

Press to select
CAPTION.

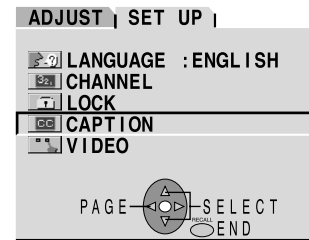

Press to display
the CAPTION screen.

2

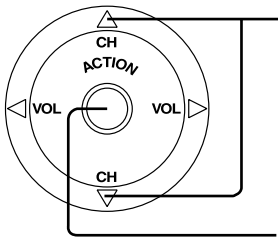

Press to select
CC ON MUTE.



Press repeatedly to select
CC ON MUTE.



3



Press to exit menu.

Notes:

- The setting for CC ON MUTE is valid only when the CC MODE is OFF, CC MODE set to ON will override CC ON MUTE.
- Closed Caption is not displayed if the input signal is COMPONENT VIDEO INPUT of 480P or more, or from RGB.

Channel Caption Feature

Station names, e.g. ABC, TNN, etc. so that they will appear when a channel is selected.
Choose 24 preset names.

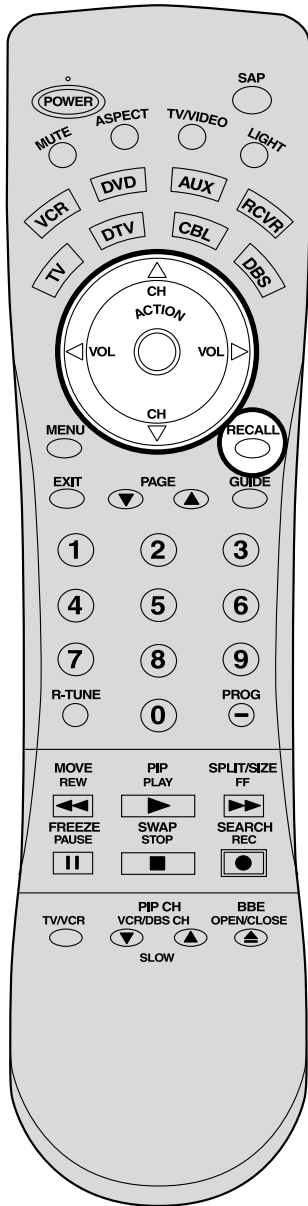

Press the ACTION button to display the MENU screen and select SET UP.

1

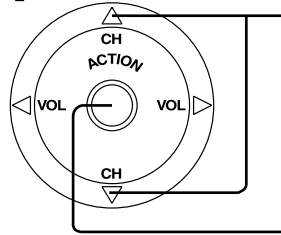

Press to select CHANNEL.

Press to display the SET UP CHANNEL screen.

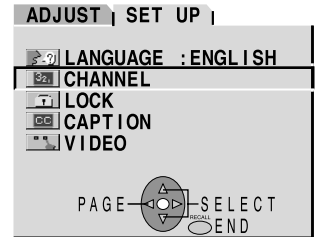

2

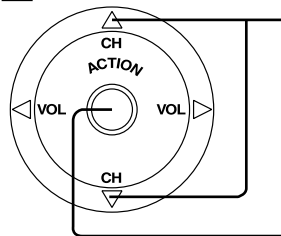

Press to select CHANNEL CAPTION.

Press to display the CHANNEL CAPTION screen.

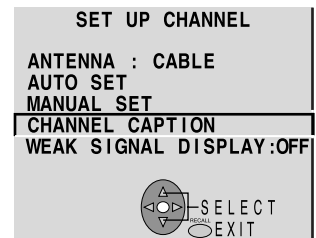

3

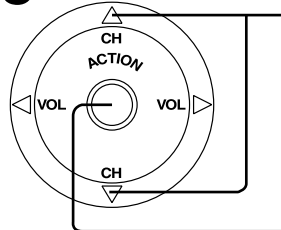

Press to select a station.

Press to move cursor to the right.

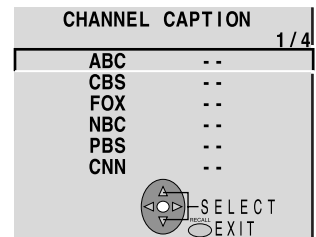

To remove a registered channel number, select the station, then press the ◀ button (CLEAR).

4

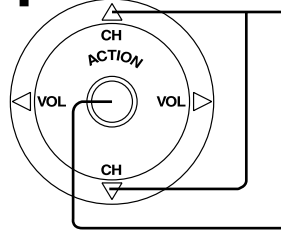

Press to select channel number.

Press to set.

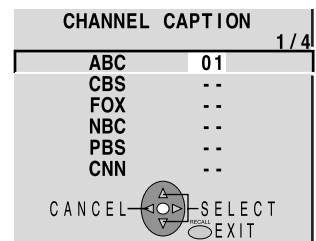

To make a correction, press the ◀ button.

- Repeat step 3 and 4 until the Caption List is complete.

5

RECALL



Press to exit menu.

Weak Signal Display Feature

When "ON" is selected, the picture is displayed even when a broadcast signal is weak or non-existent.

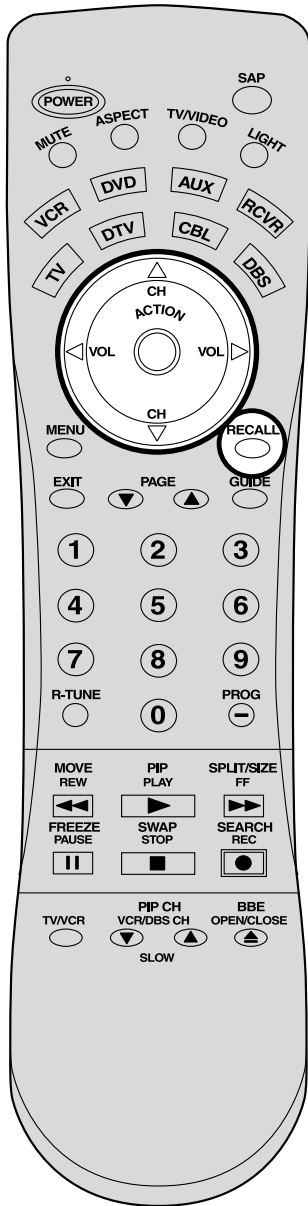

Press the ACTION button to display the MENU screen and select SET UP.

1

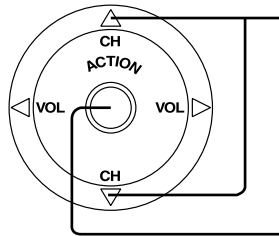

Press to select CHANNEL.

Press to display the SET UP CHANNEL screen.

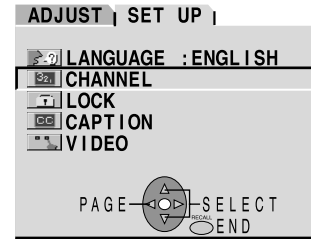

2

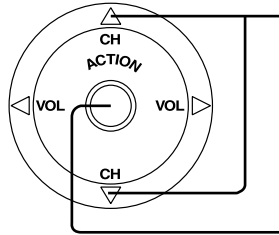

Press to select WEAK SIGNAL DISPLAY.

Press to set "ON" or "OFF".

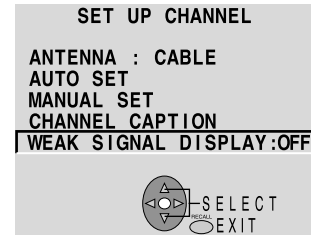

ON : Picture is displayed regardless of signal condition, and may not always be clearly visible.

OFF : Screen turns solid blue when signal is absent or weak.

3

RECALL



Press to exit menu.

Note:

If unit is connected to equipment which has blue back feature, selecting "ON" will have no effect on the other equipment.

Video NR (Noise Reduction) Feature

In the event of weak signal conditions, the Video NR circuitry reduces noise in the luminance channel. It is important to note that Video NR should remain OFF for maximum picture detail when receiving a strong signal or viewing high-quality video.

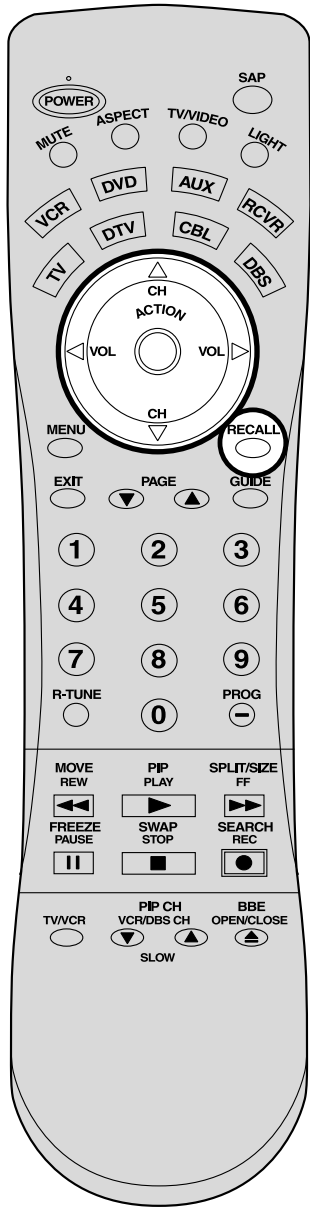

Press the ACTION button to display the MENU screen and select SET UP.

1

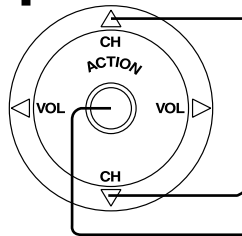

Press to select VIDEO.

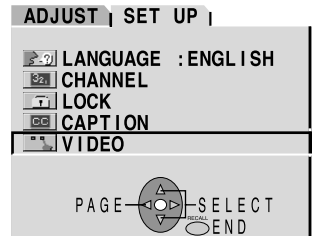

Press to display the VIDEO screen.

2

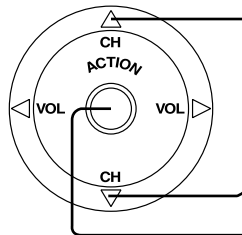

Press to select VIDEO NR.



Press to set "ON" or "OFF".

ON : When signal is noisy
OFF : When signal is high-quality

3

RECALL



Press to exit menu.

Note:

When an RGB signal is input, VIDEO NR is set to OFF only.

Automatically changing screen size

If the received signal contains screen size specifications in RF, VIDEO INPUT (1–3) or COMPONENT VIDEO INPUT (1–2), the screen size is automatically changed.

Press the ACTION button to display the MENU screen and select SET UP.

1

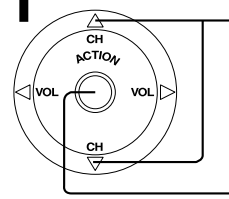

Press to select VIDEO.

Press to display the VIDEO screen.

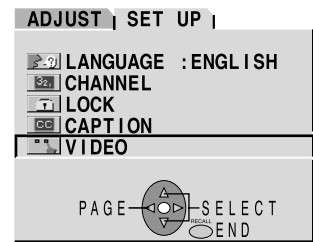

2

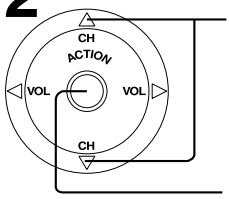

Press to select ID-1.

Press to set "ON" or "OFF".

ON : When screen size specification signals are detected, screen size is automatically changed.

OFF : The screen size is not automatically changed. (Turn OFF if this function does not operate properly.)

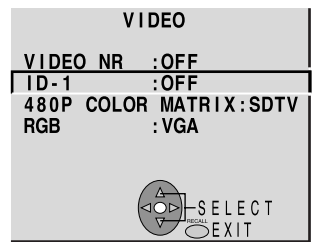

3 **RECALL**



Press to exit menu.

Notes:

- When ID-1 is detected and screen size is changed, Aspect mode will be displayed.
- When displaying split screen, ID-1 is not detected.

Setting when 480p signals (sequential scan) are input through COMPONENT VIDEO INPUT

Adjust 480p signals to achieve a natural color from digital equipment connected to COMPONENT VIDEO INPUT (Y, P_B/C_b, P_R/C_r input terminals).

Press the ACTION button to display the MENU screen and select SET UP.

1

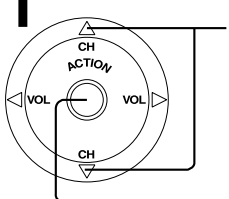

Press to select VIDEO.

Press to display the VIDEO screen.



2

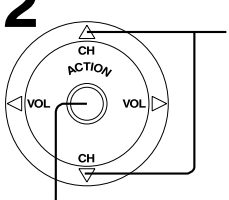

Press to select 480P COLOR MATRIX.

Press to set "SDTV" or "HDTV".

SDTV : When the input signal is a normal TV system (NTSC).

HDTV : When the input signal is a High-Definition system (HD).

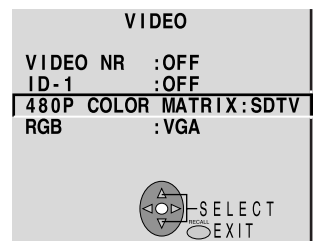

3 **RECALL**



Press to exit menu.

Note:

480p COLOR MATRIX does not need to be set when using Hi-Definition equipment or 480i output equipment.

RGB Input Feature

Set the signal to be input to the Projection display's front PC IN terminal. Most of analog RGB signals are selected automatically. When RGB input signal is VGA 60Hz from PC or 480P from other equipment, you must manually switch to the desired input.

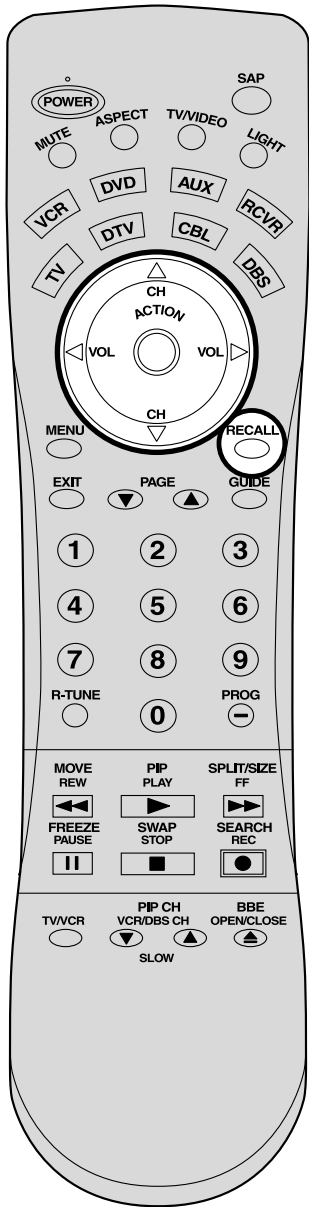

Press the ACTION button to display the MENU screen and select SET UP.

1

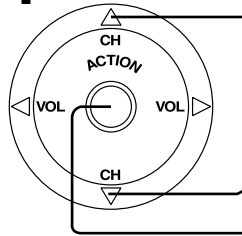

Press to select VIDEO.

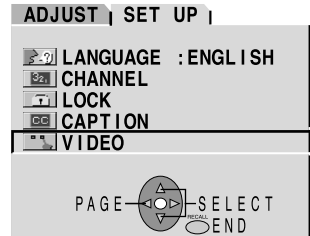

Press to display the VIDEO screen.

2

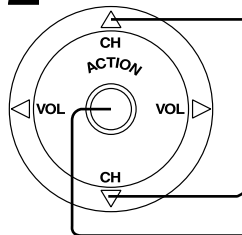

Press to select RGB.



Press to set "VGA" or "480P".

VGA : When RGB input signal is VGA 60Hz from PC
480P : When RGB input signal is 480P from other equipments

3

RECALL



Press to exit menu.

Switching languages for display

The language of the Projection display is set to English as the factory setting. To select one of 3 different languages for on-screen displays, follow the instructions below.

Press the ACTION button to display the MENU screen and select SET UP.

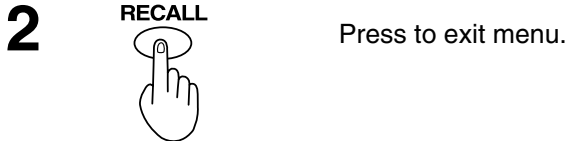
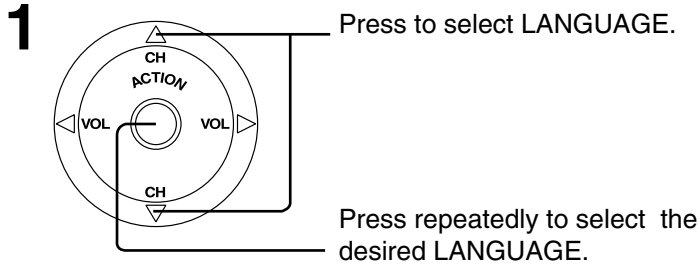

Information

You can display the input signal type. Display items differ depending on the input signal.

Press the ACTION button to display the MENU screen and select ADJUST.

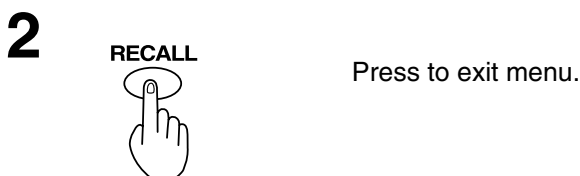
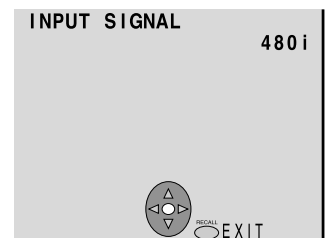
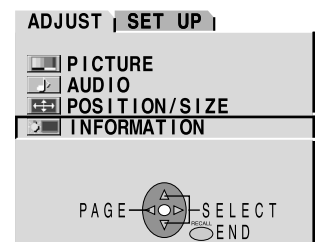
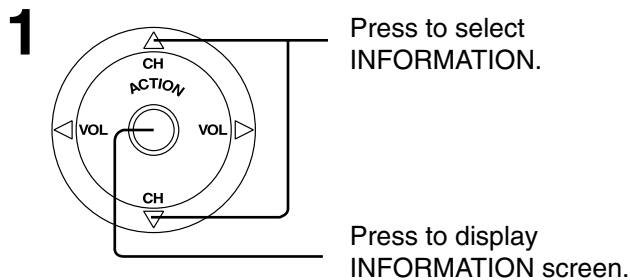

Cleaning the Air Filter

The Air Filter should be cleaned about every 400 hours.

1 When the accumulated operating time reaches 400 hours, the screen on the right will be displayed for 5 minutes. When this happens, please follow the instructions and clean the air filter. This is very important!

2 Turn the POWER button to OFF. Wait until the cooling fan stops and the POWER indicator turns solid red.

3 Remove the right Speaker cover. Place your fingertips under the Speaker cover and pull it from the Projection display.

4 Clean the Filter. Gently remove any accumulated dust from Air Filter unit with your vacuum cleaner.

CAUTION: Please be very careful not to damage or rip the filter material. Operating Projection display with torn or damaged Filter may cause damage to Projection display.

5 Replace the Speaker cover.

- Operating this unit without the air filter installed will result in dust or dirt being drawn into the LCD projection display assembly. Visibly, the picture will be degraded.

If the dust cannot be removed by cleaning, it is time to replace the air filter.

6 This screen appears when Projection display is turned on. If cleaning is done, select YES.

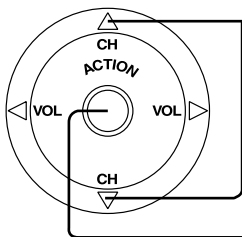

Press to select
NO or YES.

Press to set.

CAUTION: Please do not operate without the air filter. Serious damage will occur.

AIR FILTER CLEANING IS RECOMMENDED AT THIS TIME. FIRST TURN THE UNIT OFF. REMOVE THE RIGHT SPEAKER COVER AND FOLLOW THE INSTRUCTIONS. CLEANING THE AIR FILTER WILL MAXIMIZE PRODUCT RELIABILITY.

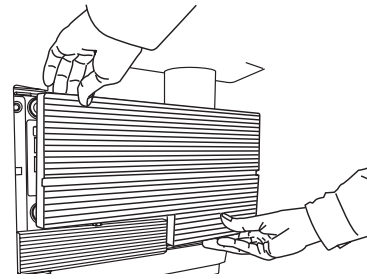

Cleaner

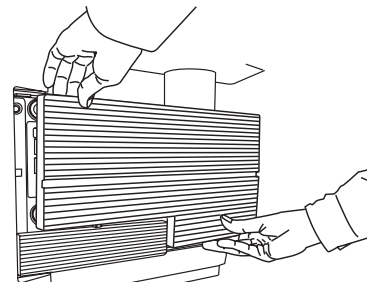
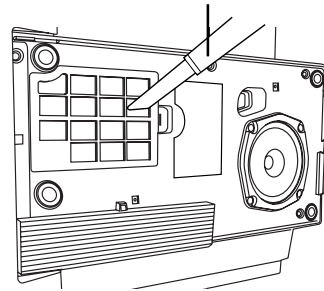

DID YOU CLEAN THE AIR FILTER?

NO.

YES.

IT IS VERY IMPORTANT.



Clogged Air Filter Detection

When a dirty or clogged air filter is detected, the screen at right is displayed for 1 minute after which the Power is turned OFF.

AIR FILTER CLEANING IS RECOMMENDED AT THIS TIME. FIRST TURN THE UNIT OFF. REMOVE THE RIGHT SPEAKER COVER AND FOLLOW THE INSTRUCTIONS. UNIT WILL BE TURNED OFF AFTER 1 MINUTE.

Note:

At this time, only the POWER button is operational. When the power is turned off with the POWER button, the usual confirming message will not appear. (P. 21)

Air Filter Replacement

Replace filter when it remains clogged, dirty or damage even after cleaning.

- 1** Remove the Air Filter unit
Grasp the indented portion of the Air Filter and pull it out of the Projection display.

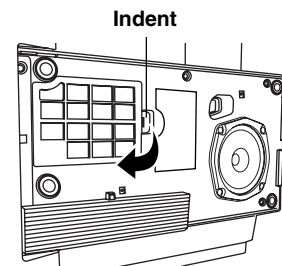

- 2** Replace the new Air Filter unit.
Slide the new Air Filter into the Projection display so that the indentations of the filter and Projection display are aligned. Then, press on the arrow mark  until you hear it snap into place.

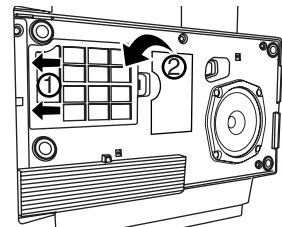

Replacing the lamp unit

The lamp unit is sold separately. To purchase a replacement, call the Panasonic accessory department, toll free at: 1-800-332-5368.

Lamp unit Part No. : TY-LA1500

Lamp unit replacement period

The lamp has a maximum life of about 5 000 hours.

- When the stipulated time is reached, “THE LAMP NEEDS TO BE REPLACED,•••” will be displayed for about 5 minutes.
- The LAMP indicator lights red.

THE LAMP NEEDS TO BE REPLACED, AND THE LAMP HOUR METER NEEDS TO BE RESET.



Due to the characteristics and use conditions of individual lamps, the lamp may cease to light before the stated lamp life.

Influences of frequent lighting, continuous light use for over 24 hours, the number of times lit, the length of time between lightings, etc. may shorten lamp life.

(Because of this, we recommend having a replacement lamp on hand.)

WARNING:

The high-pressure lamp could explode if not properly handled and lamp fragments could cause injury.

Important Points to keep in mind

When replacing the lamp unit with a new one, pay attention to the following points.

Warning:

- Because the temperature of the lamp unit is elevated immediately after its use, directly touching it may cause burns. Please allow the lamp to cool before handling or replacing the lamp unit.

Cautions for Lamp Unit Replacement:

- Handle the removed old lamp unit carefully. If handled improperly, it may have a risk of explosion.
- Wear gloves when replacing the lamp unit.
- If replacing the lamp unit becomes necessary during the operation of the TV, follow the procedure below to turn off the power and wait until the lamp unit cools completely.

1. Press the POWER button on the remote control unit to turn off the power.
2. Wait for about 1 minute until the cooling fan stops.
 - **The lamp cooling fan will continue to operate for about 1 minute after turning off the power. Do not unplug the power cord from the outlet until the fan has stopped. Avoid interrupting the power line by using circuit breakers or switchable power strips.**
3. After the cooling fan has stopped, Unplug the power cord from the outlet.

- Please wait more than one hour for lamp replacement.

[If you need to replace the lamp more urgently]

- The Projection display has a forced cooling feature. After the POWER button is turned OFF, and sometime during about the first minute of the normal cooling fan operation, press the VOL+ button on the Projection display and the ▲ button on the Remote control at same time for more than 5 seconds. The cooling fan operates for about 10 minutes.

Refer to the instructions enclosed with the lamp unit (Part No.: TY-LA1500) when replacing the lamp.

Remote Control Quick Reference Guide (Operating peripheral equipment)

Programming The Illuminated Remote Control Using Access Codes

The remote control can be preset for other manufacturers, by utilizing the **REMOTE MODE SELECTION BUTTONS** for **CABLE, DTV, VCR, RCVR** (a Receiver or Amplifier), **DVD** (DVD or CD), **DBS** and **AUX** (for **Cassette Player** or a **PVR**.) Details on remote control buttons to operate peripheral equipment. (PP. 66, 67)



1 Setting up the remote using the numerical keys. (When code is known):

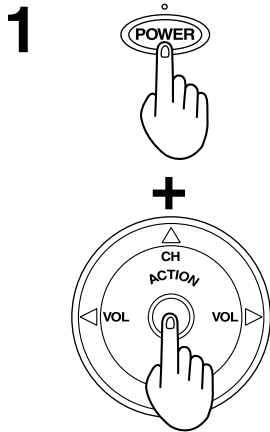

Press and hold the **POWER** and **ACTION** buttons simultaneously **for at least 5 seconds**. After 5 seconds, all the illuminated mode buttons will begin to flash. Then let go of the **POWER** and **ACTION** buttons.

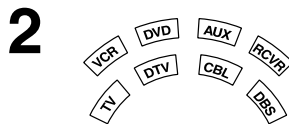

Press the desired mode button. The mode button will illuminate steadily, all others will go out.

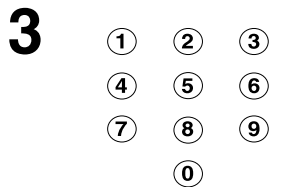

Enter the three digit set up code, by using the Remote Control Keyboard. If the correct code is entered, the mode button will blink twice and then go out. Now your remote is set for this code. Then, press the Remote Control **POWER** button to test the component. If the procedure was successful, the component will turn on.

Device	Operate	Default
TV	TV (Only Panasonic)	Panasonic Code
VCR	VCR (Preset)	Panasonic Code
CBL	Cable Boxes (Preset)	Panasonic Code
DBS	DBS Boxes (Preset)	Panasonic Code
RCVR	RCVR (Preset)	Panasonic Code
AUX	Cassette Players, PVR (Preset)	Panasonic Cassette Players Code
DVD	DVD & LD & CD Player (Preset)	Panasonic DVD Code
DTV	STB (Only Panasonic)	Panasonic Code

Notes:

- Due to changes in infra-red commands used by manufacturers, some brands have several codes. If your unit does not respond to the first code, please try the next one.
- If an incorrect number is entered (or there is an incomplete entry after 30 seconds), the button illumination goes out (no blink) and settings are unchanged.
- Repeat setup after remote battery replacement.
- Remote will not control every component made by the manufacturer listed. If you get no response, your particular component cannot be controlled. There are NO additional codes for the products listed. If your product is not listed, then the remote is not compatible with that product.

Remote Control Quick Reference Guide (Operating peripheral equipment)



2 Setting to the remote using the step and set method (When code is not known):

- 1**



Press and hold the POWER and ACTION buttons simultaneously **for at least 5 seconds**. After 5 seconds, all the illuminated mode buttons will begin to flash. Then let go of the POWER and ACTION button.
- 2**

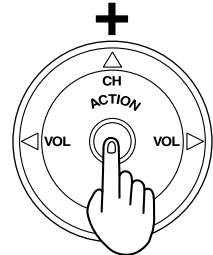

Press the mode button. The mode button will illuminate steadily, all others will go out.
- 3**

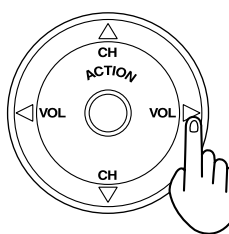

Press “▶” button to step to the next code. Press POWER button to send a test signal in that format. Continue doing this until the proper device code is found, And the target device responds.
- 4**

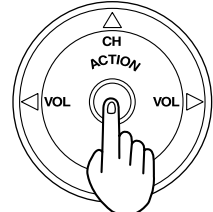

Once the code has been found, press the ACTION button to lock it in.

Notes:

- The step and set mode will start from the current device (not the beginning of the library, except for the first time).
- The step and set mode works in the reverse direction using the “◀” button.

Infrared Remote Codes for Specific Components

Helpful Hint: Write down the code numbers for your components in the space provided below. This will serve as a handy reference whenever you need to reprogram your remote control.

CABLE

Cable Box

DBS

Digital Broadcast System

Other Component

Other Component

VCR

Video Cassette Recorder

RCVR

Receiver or Amplifier

Other Component

Other Component

CD

Compact Disc Player

DVD

Digital Versatile Player

Other Component

Other Component

Remote Control Quick Reference Guide (Operating peripheral equipment)

Infrared Codes Index

The remote control is capable of operating many brands of peripheral equipment. Refer to page 61 and 62 for programming procedures.

Note: The remote control memory is limited and therefore some models may not operate. The remote control is not designed to control all features available in all models.

Note: After entering the proper infrared code, press the desired Mode Selection button on the remote control. Refer to page 8 and 66 to 67 for details on operating peripheral equipment using the remote control.

VCR Infrared Codes Index

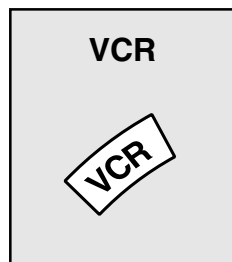

Maker List (VCR)			
Maker	Set Up No.	Maker	Set Up No.
ADMIRAL	335	ORION	320, 326
AIWA	332	PANASONIC	321, 322, 323, 324
AKAI	314, 315, 316, 329	J.C. PENNEY	300, 305, 310, 311, 324, 339, 345
AUDIO DYNAMIC	311, 339	PENTAX	300, 311, 345
BELL & HOWELL	305, 313	PHILCO	320, 323, 324, 326, 331, 343
BROKSONIC	320, 326	PHILIPS	323, 324, 331
CANON	323, 325	PIONEER	323
CITIZEN	306	PROSCAN	300, 301, 302, 323, 324, 331, 333, 345, 346
CRAIG	305, 306, 329	QUASAR	321, 322, 323, 324
CURTIS MATHES	324, 345	RADIO SHACK	305, 309, 324, 333, 336, 340
DAEWOO	301, 324, 343	RCA	300, 301, 302, 323, 324, 331, 333, 345, 346
DBX	310, 311, 339	REALISTIC	305, 309, 324, 336, 340
DIMENSIA	345	SAMSUNG	302, 304, 333
EMERSON	303, 319, 320, 325, 326, 343	SANSUI	320, 326, 339, 352
FISHER	305, 307, 308, 309, 313	SANYO	305, 309, 313
FUNAI	320, 326, 334	SCOTT	301, 302, 304, 309, 320, 326, 338, 340, 347, 348
GE	324, 333, 345	SEARS	300, 305, 306, 307, 308
GOLDSTAR	306	SHARP	335, 336
GRADIENTE	334	SHINTOM	317
HITACHI	300, 323, 345	SIGNATURE 2000	335
INSTANT REPLAY	323, 324	SINGER	317
JENSEN	339	SONY	328, 329, 330
JVC	310, 311, 334, 339	SYLVAVIA	323, 324, 331
KENWOOD	306, 310, 311, 339	TASHIRO	306
LXI	300, 305, 306, 307, 308, 309	TATUNG	310, 311, 339
MAGNAVOX	323, 324, 331	TEAC	310, 311, 339
MARANTZ	310, 311, 339	TECHNICS	321, 322, 323, 324
MARTA	306	TEKNIKA	324
MEMOREX	309, 324	TOSHIBA	301, 346
MGA	338, 340, 341, 347, 348	VECTOR RESEARCH	311
MINOLTA	300, 345	WARDS	306, 309, 335, 336, 344
MITSUBISHI	338, 340, 341, 347, 348	YAMAHA	305, 310, 311, 339
MULTITECH	304, 347	ZENITH	306, 344
NEC	310, 311, 334, 339		
OLYMPIC	323, 324		
OPTIMUS	306, 321, 328, 335		

Remote Control Quick Reference Guide (Operating peripheral equipment)

CABLE CONVERTER BOX AND DVD, CD PLAYERS Infrared Codes Index

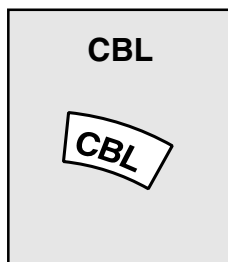

Maker List (CBL)			
Maker	Set Up No.	Maker	Set Up No.
ABC	124	PULSAR	105, 132
ARCHER	125, 132	PUSER	132
CABLEVIEW	105, 132	RCA	115
CITIZEN	105, 122	REALISTIC	132
CURTIS	112, 113	REGAL	112, 118, 140, 141, 142, 145
DIAMOND	124, 125, 132	REGENCY	134
EAGLE	129	REMBRANT	105, 132, 137
EASTERN	134	SAMSUNG	105
GCBRAND	105, 132	SCIENTIFIC ATLANTA	111, 112, 113
GEMINI	122	SLMARK	101, 105
GENERAL	111, 119, 120, 121, 122, 123,	SPRUCER	105, 110
INSTRUMENT /	124, 125, 126, 127	STARGATE	105, 132
JERROLD		TELEVIEW	101, 105
HAMLIN	112, 118, 140, 141, 142, 145	TEXSCAN	144
HITACHI	103, 124	TOCOM	135
MACOM	103, 104, 105	TOSHIBA	104
MAGNAVOX	133	UNIKA	125, 132
MEMOREX	130	UNIVERSAL	122, 132
MOVIE TIME	105, 132	VIDEOWAY	106
OAK	102, 137, 139	VIEWSTAR	129, 130
PANASONIC	109, 110, 114	ZENITH	100, 117
PHILIPS	106, 107, 128, 129, 130	ZENITH / DRAKE	100
PIONEER	101, 116	SATELLITE	

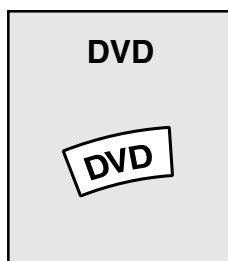

Maker List (DVD)			
Maker	Set Up No.	Maker	Set Up No.
DENON	100	SABA	101
FERGUSON	101	SAMSUNG	110
JVC	109	SHARP	108
mitsubishi	105	SONY	104
NORDMENDE	101	TECHNICS	100
PANASONIC	100	THOMSON	101
PHILIPS	103	TOSHIBA	103
PIONEER	102	YAMAHA	100
RCA	101	ZENITH	107

Maker List (CD)			
Maker	Set Up No.	Maker	Set Up No.
ADMIRAL	226	OPTIMUS	208, 218, 220, 222
AIWA	233, 235	PANASONIC	224, 225, 227
CARVER	229	PHILIPS	229, 230
DENON	242	PIONEER	208
EMERSON	239	QUASAR	224, 225, 227
FISHER	205	RCA	231, 237, 238, 247
HARMAN/KARDON	219, 220, 221, 223	SANSUI	210, 246
HITACHI	207	SANYO	205
JENSEN	234	SCOTT	210, 246
JVC	240, 241, 245	SHARP	242, 243
KARDON	223	SHERWOOD	220
KENWOOD	200, 201, 211, 245	SONY	228
LXI/SEARS	236	SOUNDESIGN	244
MAGNAVOX	229, 232	TEAC	212, 216, 218
MARANTZ	229	TECHNICS	224, 225, 227
MCINTOSH	221	VICTOR	240, 241, 245
NAKAMICHI	210	YAMAHA	202, 203, 204
ONKYO	214, 215		

Remote Control Quick Reference Guide (Operating peripheral equipment)

CASSETTE PLAYERS, PERSONAL VIDEO RECORDERS, RECEIVERS, AMPLIFIERS, and DBS Infrared Codes Index

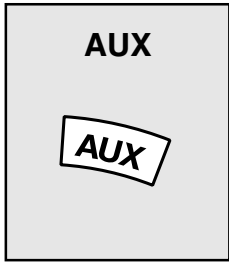

Maker List (TAPE)			
Maker	Set Up No.	Maker	Set Up No.
AIWA	223, 224, 225	PHILIPS	222
DENON	231	PIONEER	204
FISHER	203	RCA	226, 227, 228
JENSEN	214	SANSUI	205, 210
JVC	229, 230	SHARP	231
KENWOOD	200, 207	SONY	219, 220
MARANTZ	202	TEAC	210, 211, 215
NAKAMICHI	205	TECHNICS	216, 218
ONKYO	208, 209, 213	YAMAHA	201, 202
PANASONIC	216, 218		

Maker List (Personal Video Recorders)	
Maker	Set Up No.
Panasonic Replay TV	100
Philips Tivo	101
Sony Tivo 102	102

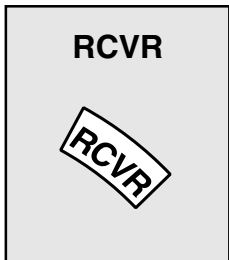



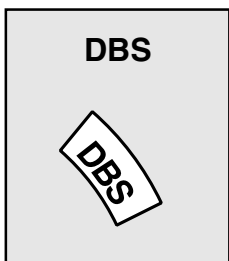









Maker List (RCVR)			
Maker	Set Up No.	Maker	Set Up No.
ADMIRAL	120	OPTIMUS	103, 127, 130, 131
AIWA	125, 126	PANASONIC	118, 119, 121
DENON	134, 135, 136	PHILIPS	123
FISHER	104	PIONEER	105, 107
GARRARD	113	QUASAR	118, 119, 121
HARMAN KARDON	115, 123	RCA	103, 105, 127, 130, 131
JENSEN	129	SANSUI	103, 111, 139
JVC	132, 133	SHARP	134, 137
KENWOOD	100, 108	SONY	122
MAGNAVOX	127	SOUNDESIGN	138
MARANTZ	124	TEAC	111, 112, 113
MCLNTOSH	116	TECHNICS	118, 119, 121
NAKAMICHI	106	VICTOR	132, 133
ONKYO	109, 114	YAMAHA	101, 102

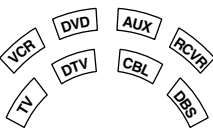
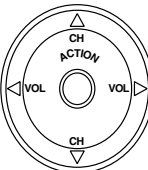

Maker List (DBS)			
Maker	Set Up No.	Maker	Set Up No.
DISH NETWORK (ECHOSTAR)	105, 115, 116	MAGNAVOX	101, 102
ECHO STAR	105	PANASONIC	104
EXPRESS VU	105, 115	PHILIPS	101, 102
G.E.	106	PRIMESTAR	108
G.I. (GENERAL INSTRUMENT)	108	PROSCAN	106, 109, 110, 113
GRADIENTE	114	RCA	106, 109, 110, 113
HITACHI	103, 111, 112	SONY	107
HNS (HUGHES)	103	STAR CHOICE	103, 108
		TOSHIBA	100
		UNIDEN	101, 102

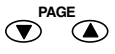
Remote Control Quick Reference Guide (Operating peripheral equipment)

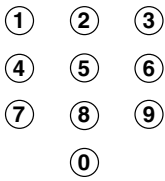
Quick Reference Functional Button Chart











BUTTON	MODE	FUNCTION
	All Components	Turns selected components On and Off
	TV	Press to access Second Audio program
	TV CBL RCVR	Mutes audio
	TV DTV DBS	Select picture size (ratio) to match programming format.
	TV RCVR	Selects the input mode
	Remote Control	Illuminate buttons
	All Components	Component mode selection for remote control
	TV CBL VCR AUX DBS RCVR DTV DVD CD TV CBL RCVR DBS DVD DTV	Channel Up/Down Navigation Up/Down Navigation Up/Down Next/Previous Track Volume (+/-) Navigation Left/Right
	TV DTV CBL DBS DVD	TV Menu DTV Menu Enter DBS Menu Select
	DVD DTV DBS	DVD Menu Menu On/Off Menu On/Off
	DBS DVD	Page Up/Down Skip +/-
	TV CBL VCR DBS DTV AUX (Cassette Deck)	Previous Channel Previous STB Channel Deck A/B
	TV VCR DBS DVD DTV CD	Onscreen Display Onscreen Display Time Format
	TV VCR CBL DBS All Components CD DVD RCVR	Selects Channel Selects Code Selects Track Selects chapter Keys 1,2,3 and 4 select A/V inputs; 5 CD; 6 Tuner; 7Phono; 8 Cassette Deck; 9 Aux
	DTV DBS	Exit Menu

Notes:

- Not all functions listed may be controllable.
- Some TV, Cable Box and DSS Receiver brands require you to turn on the power manually.

Remote Control Quick Reference Guide (Operating peripheral equipment)

Quick Reference Functional Button Chart

BUTTON	MODE	FUNCTION
GUIDE 	DTV DBS DVD CD	DTV Guide (Electronic Program Guide) DBS Guide Title Next Disc
PROG 	DTV DBS	Delimiter between major and minor channel number
MOVE REW 	TV VCR AUX (Cassette Deck) DVD CD RCVR	PIP Move Rewind Skip Search Fast Rewind Search Fast Rewind Search Fast Rewind Surround (-)
PIP PLAY 	TV VCR AUX (Cassette Deck) DVD CD	PIP On/Off Play Play Play Play
SPLIT/SIZE FF 	TV VCR AUX (Cassette Deck) DVD CD RCVR	SPLIT function / PIP Size Fast Forward Fast Forward Skip Search Fast Forward Skip Search Fast Forward Surround (+)
FREEZE PAUSE 	TV VCR AUX (Cassette Deck) CD DVD	Freeze Pause Pause Still
SWAP STOP 	TV VCR DVD CD AUX (Cassette Deck)	PIP Swap / SPLIT swap Stop Stop Stop Stop
SEARCH REC 	TV DTV VCR AUX (Cassette Deck) DBS	Channel Search Info (EPG) Record Record Record
TV/VCR 	VCR DBS	TV/VCR switch TV/DBS switch
PIP CH VCR/DBS CH SLOW 	TV VCR DVD DBS CD RCVR	PIP Channel Up/Down Channel Up/Down Slow +/- Channel Up/Down Repeat/Random Center Channel (+/-)
BBE OPEN/CLOSE 	TV DVD CD AUX (Cassette Deck)	BBE Sound On/Off Open/Close Open/Close Open/Close

Troubleshooting

Before you call for service, determine the symptoms and make a few simple checks as shown below.

Symptoms	Checks	Page
Power does not turn ON	<ul style="list-style-type: none"> Is the power plug plugged in? 	21
Lamp does not light up.	<ul style="list-style-type: none"> If the Lamp will not light after turning on the power 2 or 3 times, the Lamp may be damaged. Please consult your nearest dealer. 	-
<p>The power turns OFF</p> <p>The POWER indicator flashes orange twice every 5 seconds.</p> <p>The TEMP indicator flashes 2 or 4 times every 5 seconds.</p> <p>The TEMP indicator flashes 5 times every 5 seconds.</p> <p>Power turns off while another indicator is flashing.</p>	<ul style="list-style-type: none"> The lamp cover is ajar. Firmly replace the cover. Check whether or not the vents are clogged. Is the set being used in a location that is hot? Please clean the Air Filter. Please consult your nearest dealer. 	<p>60</p> <p>-</p> <p>-</p> <p>58</p> <p>-</p>
Remote control does not function	<ul style="list-style-type: none"> Are the batteries dead or inserted incorrectly? Is the remote control sensor in direct light of fluorescent lamps or other strong sources of light? Did you correctly set the remote control code? 	<p>7</p> <p>-</p> <p>61</p>
<p>Image shakes</p> <p>Image is not clear</p> <p>Color patches or no color</p>	<ul style="list-style-type: none"> Is the antenna or antenna cable old, broken or shorted? Is the antenna cable connected properly? When using a VCR and selecting channels on the TV, is the TV/VIDEO mode for the VCR set to TV? 	<p>-</p> <p>12-14</p> <p>-</p>
Image appears doubled or tripled.	<ul style="list-style-type: none"> Is the antenna facing the right direction? Is the antenna receiving any signals reflected off of mountains or buildings. 	<p>-</p> <p>-</p>
Images disappear at the top and bottom of the screen	<ul style="list-style-type: none"> When using 16:9 image software, there is no picture at the top and bottom of the screen (cinema vision size software, etc.). 	-
During ZOOM modes, the image is cut off at the top and bottom.	<ul style="list-style-type: none"> Has the screen position been changed? If so, adjust screen positioning. 	30,31,40,41
The projection display set makes a high whistling sound when the power is ON.	<ul style="list-style-type: none"> This is the sound of the internal starting UP. This is not a malfunction. 	-
Some parts of the screen are always lit while others do not light up. Some parts of the screen do not light up.	<ul style="list-style-type: none"> This is a characteristic of the LCD panel and not a malfunction. 	-
Fan is operating even though TV Power is OFF.	<ul style="list-style-type: none"> This is because the cooling fan is operating. The fan will stop after about 1 minute. 	21
An OSD instructing to clean the filter is displayed.	<ul style="list-style-type: none"> After cleaning the filter, select YES. 	58
An OSD instructing to replace the lamp is displayed. (The LAMP indicator is lit red.)	<ul style="list-style-type: none"> Replace lamp with a new one. 	60
Relighting the lamp when it is hot makes a sound.	<ul style="list-style-type: none"> This is a characteristic of the lamp and not a malfunction. 	-
Leaving stationary images, such as still video images, web pages, or filler bars (used for NORMAL aspect mode), on-screen for an extended period of time can leave ghost images on the screen.	<ul style="list-style-type: none"> This is a characteristic of the LCD panel and not a malfunction. Try displaying constantly moving pictures which fill the entire screen, or turn the power OFF for a while to return the screen to normal. 	-

Specifications

	PT-40LC12	PT-45LC12
Power Source	AC 120 V, 60 Hz	
Power Consumption	Power ON: Approx. 280 W Power OFF: Approx. 3 W (when cooling fan is stopped)	
LCD panels	0.9" Poly silicon TFT LCD panel X 3 921 600 (1 280 X 720) stripe pixels X 3 panels (16:9)	
Display	40-inch, 16 : 9 aspect ratio	45-inch, 16 : 9 aspect ratio
Speaker	2 Speakers 20 W [10 W + 10 W] (10 % THD)	
HID Lamp	150 W HID (High Intensity Discharge) Lamp	
Channel Capability	VHF-12 : UHF-56 : Cable-113	
Input Terminals	<p>RGB INPUT RGB analog 0.7 Vp-p (75 Ω) (D-SUB15P) AUDIO 0.5 Vrms (M3 Stereo mini Pin Jack)</p> <p>AV INPUT 1- 3 VIDEO 1.0 Vp-p (75 Ω) (RCA Pin Jack) S-VIDEO Y : 1 Vp-p (75 Ω), C : 0.286 Vp-p (75 Ω) (Mini DIN 4pin) AUDIO L-R 0.5 Vrms (RCA Pin Jack x 2)</p> <p>COMPONENT Y 1.0 Vp-p (with sync)(75 Ω)(Pin Jack) VIDEO INPUT 1-2 P_B / P_R ± 0.35 Vp-p(75 Ω) (Pin Jack x 2) AUDIO L-R 0.5 Vrms (RCA Pin Jack x 2)</p>	
Output signals	<p>AV OUT VIDEO 1.0 Vp-p (75 Ω) (RCA Pin Jack) S-VIDEO Y : 1 Vp-p (75 Ω), C : 0.286 Vp-p (75 Ω) (Mini DIN 4pin) AUDIO L-R 0.5 Vrms (RCA Pin Jack x 2)</p>	
Dimensions (W x H x D)	970 mm (W) x 898 mm (H) x 415 mm (D) 38-3/16" (W) x 35-3/8" (H) x 16-5/16" (D)	1 081 mm (W) x 978 mm (H) x 415 mm (D) 42-9/16" (W) x 38-1/2" (H) x 16-5/16" (D)
Weight (Mass)	42 kg (92.6 lbs.) Net	44 kg (97.0 lbs.) Net



Operating conditions	Temperature : 0 °C – 40 °C (34 °F - 104 °F) Humidity : 20 % - 80 % (non-condensing)
-----------------------------	--

Note:

Design and Specifications are subject to change without notice. Weight and Dimensions shown are approximate.

Cleaning

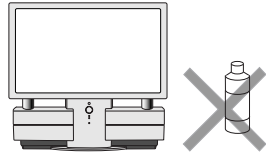
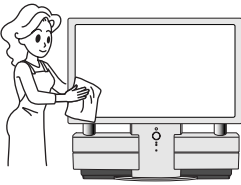
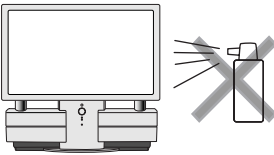
To ensure continued excellent performance by this product, periodic cleaning is recommended.

	<p>The unit contains many plastic parts. For this reason DO NOT use benzene, thinner or other chemicals to clean the unit.</p>		<p>Dust will accumulate on the picture screen. Please wipe with a soft cloth from time to time. If you use a chemically treated cloth, please be careful to follow the instructions that come with the cloth.</p>
	<p>DO NOT bring into contact with insecticide or other volatile substances. DO NOT allow the unit to come into contact for extended periods with rubber or vinyl products.</p>		<p>Remove dirt and soiling by wiping with a light cloth. Even if the unit is heavily soiled, do not apply cleaner directly to the unit. Soak a cloth in a solution of neutral cleanser diluted with water. Then wring out the cloth, wipe the unit clean, and finish by wiping with a dry cloth. Do not use any type of cleansers on the picture screen.</p>

Customer Services Directory

For Product Information, Operating Assistance, Literature Request, Dealer Locations, and all Customer Service inquiries please contact:
1-888-VIEW-PTV (1-888-843-9788), Monday-Friday 9am - 9pm; Saturday-Sunday 9am - 7pm, EST.

Web Site: <http://www.panasonic.com>
You can purchase parts, accessories or locate your nearest servicer by visiting our Web Site.

Accessory Purchases:

1-800-332-5368 (Customer Orders Only)
Panasonic Services Company 20421 84th Avenue South, Kent, WA 98032
(6 am to 5 pm Monday - Friday; 6 am to 10:30 am Saturday; PST)
(Visa, MasterCard, Discover Card, American Express, Check)

Service in Puerto Rico
Matsushita Electric of Puerto Rico, Inc. Panasonic Sales Company/Factory Servicer:
Ave. 65 de Infanteria, Km. 9.5, San Gabriel Industrial Park, Carolina, Puerto Rico 00985
Phone (787) 750-4300 Fax (787) 768-2910

As of March 2002

Limited Warranty

PANASONIC CONSUMER
ELECTRONICS COMPANY, DIVISION
OF MATSUSHITA ELECTRIC
CORPORATION OF AMERICA
One Panasonic Way
Secaucus, New Jersey 07094

PANASONIC SALES COMPANY,
DIVISION OF MATSUSHITA
ELECTRIC OF PUERTO RICO, INC.,
Ave. 65 de Infantería, Km. 9.5
San Gabriel Industrial Park, Carolina,
Puerto Rico 00985

Panasonic Multi-Media Projection Display Limited Warranty

Limited Warranty Coverage

If your product does not work properly because of a defect in materials or workmanship, Panasonic Consumer Electronics Company or Panasonic Sales Company (collectively referred to as "the warrantor") will, for the length of the period indicated on the chart below, which starts with the date of original purchase ("warranty period"), at its option either (a) repair your product with new or refurbished parts, or (b) replace it with a new or a refurbished product. The decision to repair or replace will be made by the warrantor.

CATEGORY	PARTS	LABOR	SERVICE
Multi-Media Projection Display	One (1) Year	One (1) Year	In-Home or Carry-In

During the "Labor" warranty period there will be no charge for labor. During the "Parts" warranty period, there will be no charge for parts. You must carry-in your product or arrange for in-home service during the warranty period. If non-rechargeable batteries are included, they are not warranted. This warranty only applies to products purchased and serviced in the United States or Puerto Rico. This warranty is extended only to the original purchaser of a new product which was not sold "as is". A purchase receipt or other proof of the original purchase date is required for warranty service.

Carry-in or In-Home Service

For In-Home or Carry-In Service in the United States call 1-888-VIEW-PTV (1-888-843-9788).
For assistance in Puerto Rico call Panasonic Sales Company (787)-750-4300 or fax (787)-768-2910.

In-Home service requires clear, complete and easy access to the product by the authorized servicer and does not include removal or re-installation of an installed product. It is possible that certain in-home repairs will not be completed in-home, but will require that the product, or parts of the product, be removed for shop diagnosis and/or repair and then returned.

Limited Warranty Limits And Exclusions

This warranty ONLY COVERS failures due to defects in materials or workmanship, and DOES NOT COVER normal wear and tear or cosmetic damage. The warranty also does not cover damages which occurred in shipment, or failures which are caused by products not supplied by the warrantor, or failures which result from accidents, misuse, abuse, neglect, mishandling, misapplication, alteration, faulty installation, set-up adjustments, misadjustment of consumer controls, improper cleaning of or failure to clean the air filter, power line surge, lightning damage, modification, or commercial use (such as in a hotel, office, restaurant, or other business), rental use of the product, service by anyone other than a Factory Servicenter or other Authorized Servicer, or damage that is attributable to acts of God.

THERE ARE NO EXPRESS WARRANTIES EXCEPT AS LISTED UNDER "LIMITED WARRANTY COVERAGE". THE WARRANTOR IS NOT LIABLE FOR INCIDENTAL OR CONSEQUENTIAL DAMAGES RESULTING FROM THE USE OF THIS PRODUCT, OR ARISING OUT OF ANY BREACH OF THIS WARRANTY. (As examples, this excludes damages for lost time, cost of having someone remove or re-install an installed unit if applicable, or travel to and from the servicer. The items listed are not exclusive, but are for illustration only.) **ALL EXPRESS AND IMPLIED WARRANTIES, INCLUDING THE WARRANTY OF MERCHANTABILITY, ARE LIMITED TO THE PERIOD OF THE LIMITED WARRANTY.**

Some states do not allow the exclusion or limitation of incidental or consequential damages, or limitations on how long an implied warranty lasts, so the exclusions may not apply to you.

This warranty gives you specific legal rights and you may also have other rights, which vary, from state to state. If a problem with this product develops during or after the warranty period, you may contact your dealer or Servicenter. If the problem is not handled to your satisfaction, then write to the warrantor's Consumer Affairs Department at the addresses listed for the warrantor.

PARTS AND SERVICE (INCLUDING COST OF AN IN-HOME SERVICE CALL, WHERE APPLICABLE) WHICH ARE NOT COVERED BY THIS LIMITED WARRANTY ARE YOUR RESPONSIBILITY.

Index

Symbols

1080 i	16, 19
480 i	16, 19
480 p	16, 19
720 p	16, 19

A

ACTION button	9, 22
ASPECT button	9, 30
Auto shut off	29
AV out terminals	11

B

BBE	43
Blocking Message	49

C

CH buttons (remote control)	9, 22
Channel up / down buttons (projection display) ..	10, 29
Component signal input terminals	11

F

Freezing pictures	34
Function buttons	8

I

ID-1	55
Input 1 terminals	11
Input 2 terminals	11
Input 3 terminals	10

L

LAMP indicator	10
Left screen	36
Light button	9

M

Main picture	36, 38
Main screen	38
Mode Selection buttons	8
MUTE button	8

N

Number keys	8
-------------------	---

P

PC Input terminal	10
Phones jack	10
PIP screen	38
POWER button	8, 21
POWER button/POWER indicator	10, 21, 60

R

R-TUNE button	8
RECALL button	9, 23, 29
Receivable Broadcast Types	35
Remote Control Sensor	10, 28
Reset User's Memory Functions	49
RGB	33
RGB cable	18
Right screen	36

S

SAP button	9
Sound mute	34
Speaker cover	10
Specifications	69
SVGA	19

T

TEMP indicator	10
TV/VIDEO button	9, 33

U

Using stereo system	17
Using VCR	14

V

VESA	19
VGA	19
VHF/UHF terminal	11
VOL buttons (remote control)	9, 22
Volume +/- buttons (projection display)	10, 28

X

XGA	19
-----------	----

Y

Y, PB / Cb, PR / Cr	16
---------------------------	----

Customer' Record

The serial number of this product can be found on its back cover. You should note this serial number in the space provided below and retain this book, plus your purchase receipt, as a permanent record of your purchase to aid in identification in the event of theft or loss, and for Warranty Service purposes.

Model Number PT-40LC12/PT-45LC12

Serial Number

Panasonic Consumer Electronics Company, Division of
Matsushita Electric Corporation of America
One Panasonic Way Secaucus New Jersey 07094

Panasonic Sales Company, Division of Matsushita Electric of
Puerto Rico Inc. ("PSC")
Ave. 65 de Infanteria, Km 9.5 San Gabriel Industrial Park,
Carolina, Puerto Rico 00985